



Strong Shoring, Strong Service

Hydraulic Shoring Tab Data

General Information

General Information for Using Hydraulic Aluminum Shoring

- A. The hydraulic aluminum shoring system tabulated data is based on the OSHA Safety requirements defined in 29 CFR, Part 1926, Subpart P - Excavations and Trenches.
- B. This data is to be used by a soils engineer, or a competent person. The competent person shall be experienced and knowledgeable of trenching and excavation procedures, these of hydraulic shoring systems, soils identification, and the OSHA standards.
- C. The competent person shall continually monitor the excavation for signs of deterioration such as seepage of water or flowing soil into the excavation. Promptly dewater any accumulated water and reassess the trench for safety. Changing soil conditions may require adjustments to the shoring system.
- D. The tabulated data shall only be used for those soil conditions indicated. The data is not considered adequate when loads imposed by structures, equipment, traffic, or stored materials adjacent to the trench exceed the assumed design surcharge loads of 20,000 pounds, or the imposed load of a 2 ft. spoil pile located less than 2 ft. from the edge of the excavation. An engineered shoring design is required for conditions other than those assumed in the tables.
- E. When only the lower portion of a trench is to be shored and the remaining portion is benched or sloped at an angle steeper than three horizontal to one vertical (3H:1V), the shoring members shall be selected from the tabulated data for use at a depth which is determined from the top of the overall trench and not the toe of the sloped portion.
- F. The faces of the excavation shall be straight and near vertical. Shoring members must bear on firm soil or solid filler.
- G. Trenches shall be kept dry and free of water at all times.
- H. Vertical and/or horizontal lateral loads shall not be applied to the hydraulic cylinders..
- I. Once cylinders are pressurized between 750 - 1500 PSI, the soil should not give and reduce the pressure within the cylinder.
- J. Plywood sheeting shall be 1.125" thick CDX or .75" thick, 14 ply, arctic birch. Note that the plywood is not intended as a structural member, but only for the prevention of local raveling or sloughing of the trench face between the shores.
- K. When plywood sheeting is used, it shall extend to the top of the excavation and to within 2 ft. of the bottom of the excavation in Type A & B soils, and to the bottom of the trench in Type C-60 soils. See typical installation diagrams.
- L. Plywood sheeting, as referenced throughout this tabulated data may be substituted with other engineered sheeting, such as (1) 0.75 in. thick, 14 ply, white birch - Finland Form; also known as Metsaform, Wisiform and Chudoform, (2) 1.125 in. thick soft plywood, (3) 0.25 in. thick steel plate, with a min. yield strength (fy) of 50,000 psi., (4) 0.3125 in. thick steel plate, with a min. yield strength (fy) of 36,000 psi., (5) 0.75 in. thick, 13 ply, plywood consisting of both hardwood and soft wood veneers, known as OMNI FORM, (6) Efficiency 2-3/4" thick or 4-9/16" thick extruded aluminum Build-A-Box or XLAP panels, (7) 0.75 in. thick Sentry Panel.



Safe-T-Shore
375 Comstock Dr.
Chandler, AZ 85225
800-380-0103 • 480-838-5329 • Fax: 480.838.5836
www.safe-t-shore.com

General Information	1
Soil Classification	2
Vertical Shoring and Waler System Notes	3
Vertical Shoring System	
System Selection Guide	4
Vertical Rail Specifications	5-6
Installation Examples	7-8
Installation Guide	9
Removal Guide	10
Waler Shoring System	
Waler Selection Guide	11-13
Waler Rail Specifications	14-15
Installation Examples	16-18
Hi-Clearance Shores	19-22

Classification of Soil Types

A. The soil descriptions for OSHA Type "A", "B", & "C" Soils are based on Appendix A to OSHA Subpart P of 29CFR Part 1926, "Excavations and Trenches". The Type "C-60" Soil referred to in Efficiency's Tabulated Data represents a more stable soil condition than the Type "C" described in Appendix A.

B. **Type "A" Soil** - Equivalent weight effect of **25 PSF** per foot of depth.

Description: Cohesive soil (i.e., silt, silty clay, sandy clay, clay loam) with an unconfined compressive strength of 1.5 TSF (tons per square foot) or greater; or cemented soils such as caliche and hardpan. No soil is Type A if the soil is fissured; subject to vibration from heavy traffic, pile driving or similar effects; has been previously disturbed; or part of a sloped, layered system where the layers dip into the excavation on a slope of four horizontal to one vertical (4H:1V) or greater.

C. **Type "B" Soil** - Equivalent weight effect of **45 PSF** per foot of depth.

Description: Cohesive soil with an unconfined compressive strength greater than .5 TSF but less than 1.5 TSF; and granular cohesionless soils including angular gravel, silt, silt loam, sandy loam, and in some cases, silty clay loam and sand clay loam; previously disturbed soils except those which would otherwise be classed as Type C; soil that meets requirements for Type A, but is fissured or subject to vibration; dry rock that is unstable; and material that is part of a layered system where layers dip into the excavation on a slope less steep than four horizontal to one vertical (4H:1V), but only if the material would otherwise be classified as Type B.

D. **Type "C-60" Soil** - Equivalent weight effect of **60 PSF** per foot of depth.

Description: Soft cohesive to moist soil with an unconfined compressive strength less than .5 TSF; moist cohesive soil or moist dense sand which is not flowing or submerged. When cut with near vertical side walls, soil can stand with unsupported vertical sidewalls long enough for shoring installation. (see "1.c.")

E. **Type "C-80" Soil** - Equivalent weight effect of **80 PSF** per foot of depth.

Description: Cohesive soil with an unconfirmed compressive strength of .5 TSF or less; granular soils including gravel, sand, and loamy sand; submerged soil or soil from which water is freely seeping; submerged rock that is not stable; and material in a sloped, layered system where the layers dip into the excavation on a slope of four horizontal to one vertical (4H : 1V) or steeper.



Strong Shoring, Strong Service

Hydraulic Shoring Tab Data

Shoring Systems

Vertical Hydraulic Shoring System:

- A. Trenches exceeding 8 ft. in length will have a minimum of 3 shores spaced according to the tables. In trenches shorter than 8 ft. in length, 2 sets of vertical shores are required at the horizontal spacing indicated in the tables.
- B. For trenches 6 ft. in depth, vertical shoring shall consist of a minimum of one single cylinder rail. The bottom or single cylinder shall be positioned no more than four ft. from the bottom of the trench and there shall be no more than two ft. from the top of the trench to the top or single cylinder. See typical installation diagrams.
- C. For trenches 6 to 10 ft. in depth, vertical shoring shall consist of a minimum of two hydraulic cylinders in each vertical plane. See typical installation diagrams.
- D. Two single shores may be substituted for one vertical shore.
- E. Do Not butt rails back to back across an excavation.
- F. This standard applies to both standard and rescue shores

Hydraulic Waler Shoring System:

- A. Timber sheeting shall be #1 Douglas Fir with a minimum Fb = 1,500 psi, or equivalent.
- B. When timber sheeting is used in Type C soil, the maximum distance from the bottom of the excavation to the bottom wale shall be 2' - 6" unless the sheeting is over-driven into the bottom of the trench a minimum of 1 ft. If over-driven, the maximum distance to the bottom wale shall be 4 ft.. See typical installation diagrams.
- C. A minimum of 2 sets of waler rails shall be used, one above the other. A single set of waler rails does not provide adequate protection.
- D. When double hydraulic cylinders are required at one location, both cylinders must be pressurized the same to prevent the possible failure of a single cylinder.
- E. Walers shall be placed end to end where more than one is used in the horizontal direction.

This tabulated data is applicable to any vertical hydraulic shoring system or hydraulic waler shoring system manufactured by Efficiency Production, Inc. or Safe-T-Shore.

Hydraulic Aluminum Shoring - Tabulated Data

Depth of Trench (ft.) (5)	Max. Horizontal Shoring Spacing (ft.) (6)	Maximum Vertical Cylinder Spacing (ft.) (1)	Max. Width of Trench (ft.) (2)	Sheeting
TYPE "A" SOIL				
Up To 10'	8'	4'	12'	(3)
11' To 15'	8'	4'	12'	(3)
16' To 20'	8'	4'	12'	(3)
21' To 25'	8'	4'	12'	(3)
TYPE "B" SOIL				
Up To 10'	8'	4'	12'	(3)
11' To 15'	7'	4'	12'	(3)
16' To 20'	6'	4'	12'	(3)
21' To 25'	5'	4'	12'	(3)
TYPE "C-60" SOIL				
Up To 10'	6'	4'	12'	(3)
11' To 15'	5'	4'	12'	(4)
16' To 20'	4'	4'	12'	(4)
21' To 25'	3'	4'	12'	(4)
TYPE "C-80" SOIL				
N/A (SEE NOTE 5)				

NOTES:

- Utilize Efficiency's 2 in. diameter hydraulic cylinders with standard or heavy duty extension system as required for desired excavation width. Trenches wider than 9'-4" (112") require Efficiency's Steel Oversleeves extending the full, collapsed length.
- Plywood sheeting shall consist of 1.125 in. CDX plywood or .75 in., 14 ply Arctic Birch.*
- Plywood sheeting required if raveling or sloughing is likely to occur. (see installation diagrams)*
- Plywood sheeting shall be used.*
- Material can stand with unsupported vertical sidewalls long enough for shoring installation.
- Vertical shoring shall be Efficiency's standard or heavy duty vertical rail sections. (see pg 6).

* See "L." of "General Information" for alternate sheeting.



Section Properties

Vertical Rail Specification Sheet

	Standard Rail	Heavy Duty Rail
Material	Aluminum	Aluminum
Alloy	6061-T6	6061-T6
Area	2.45 in.	3.47 in. ²
Weight	2.94 plf	4.17 plf
Section Modulus - Top (leg side)	0.44 in. ³	1.25 in. ³
Section Modulus - Bottom (blade side)	1.29 in. ³	2.38 in. ³
Equivalent Timber Size * (#2 Douglas Fir)	3x10 (flat)	4x10 (flat)

Standard Vertical Rail

Heavy-Duty Vertical Rail

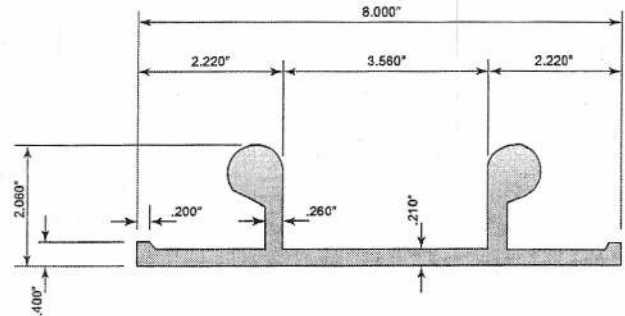
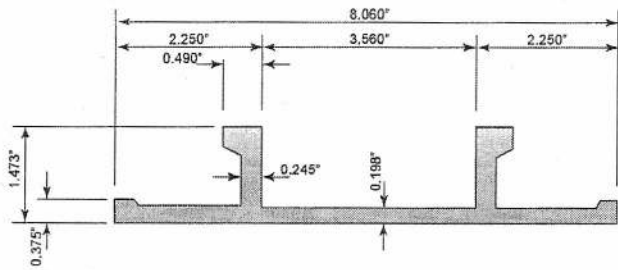
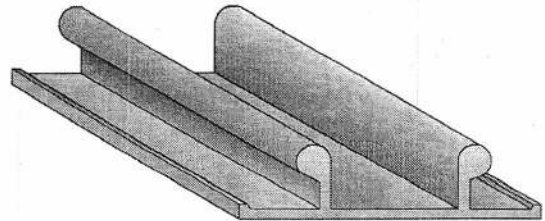
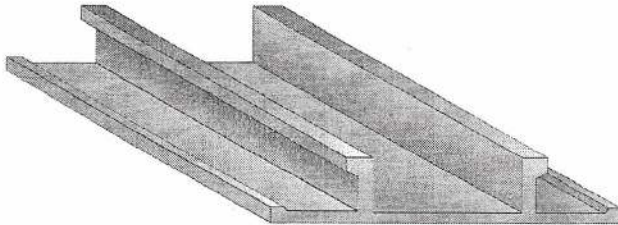

Cross Section of Standard Vertical Rail

Cross Section of Heavy-Duty Vertical Rail

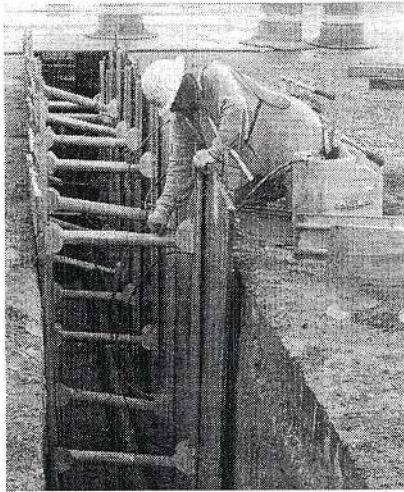

Vertical shore (with finger guards) and pump can.

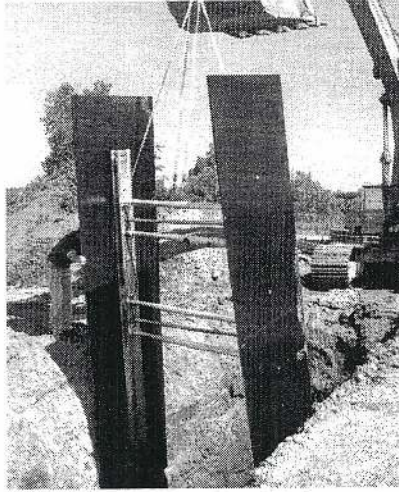

Rails may be bolted to Finform, etc. (See pg. 1 for alternate sheeting)

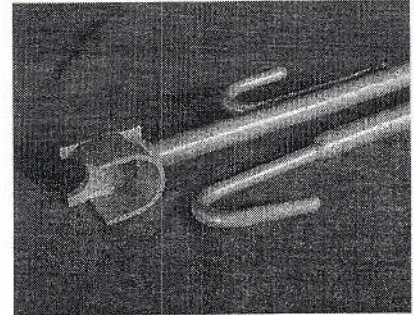

Release Tool and Removal Hook.

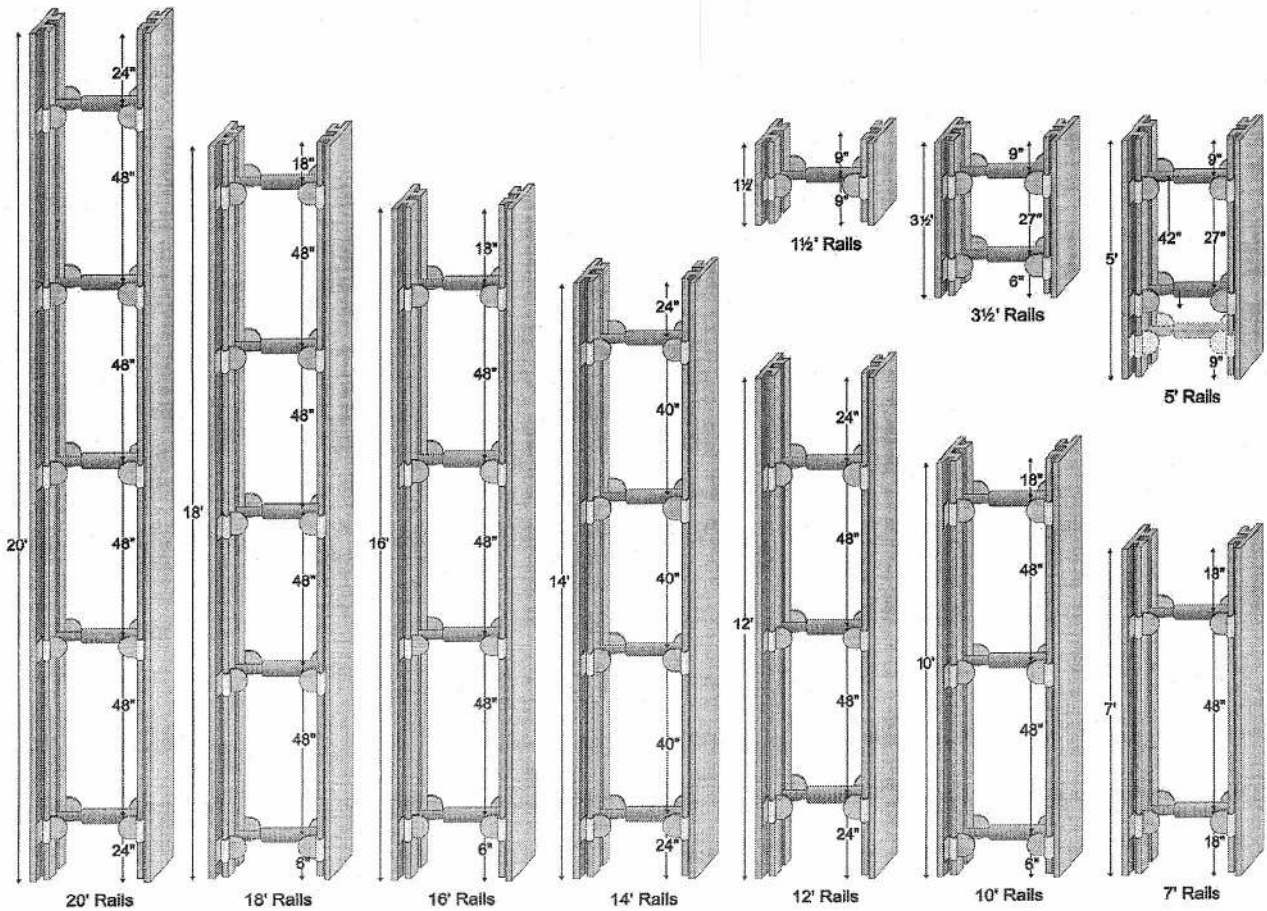

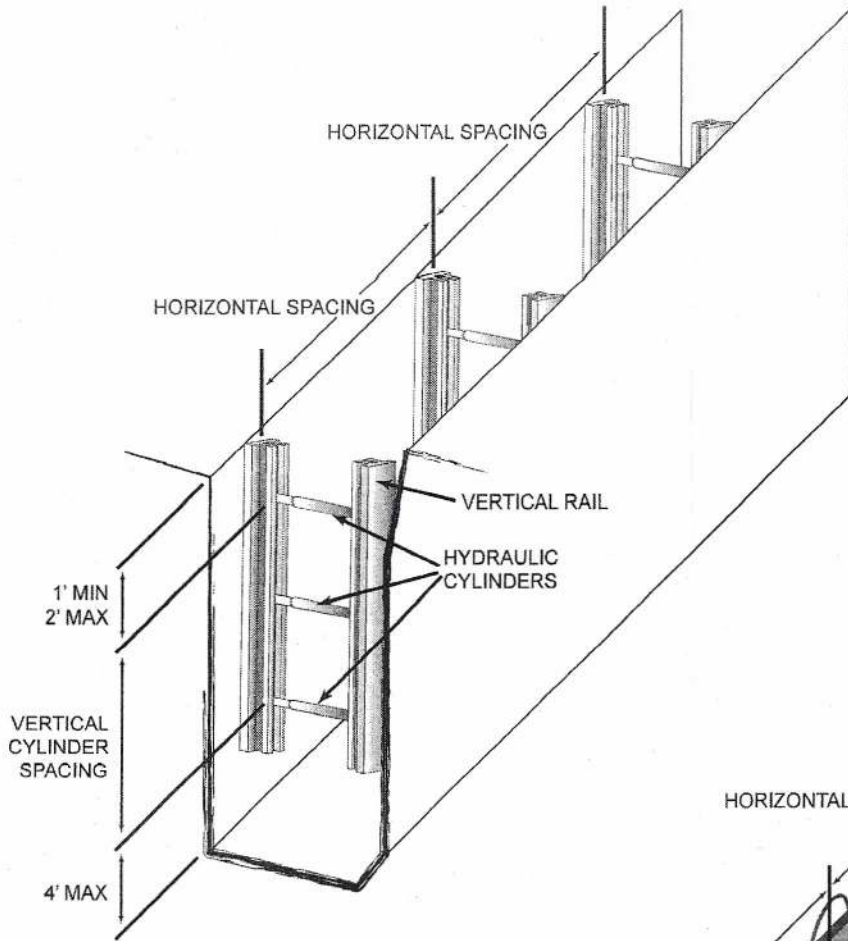

**Soil Type A & B
without plywood**

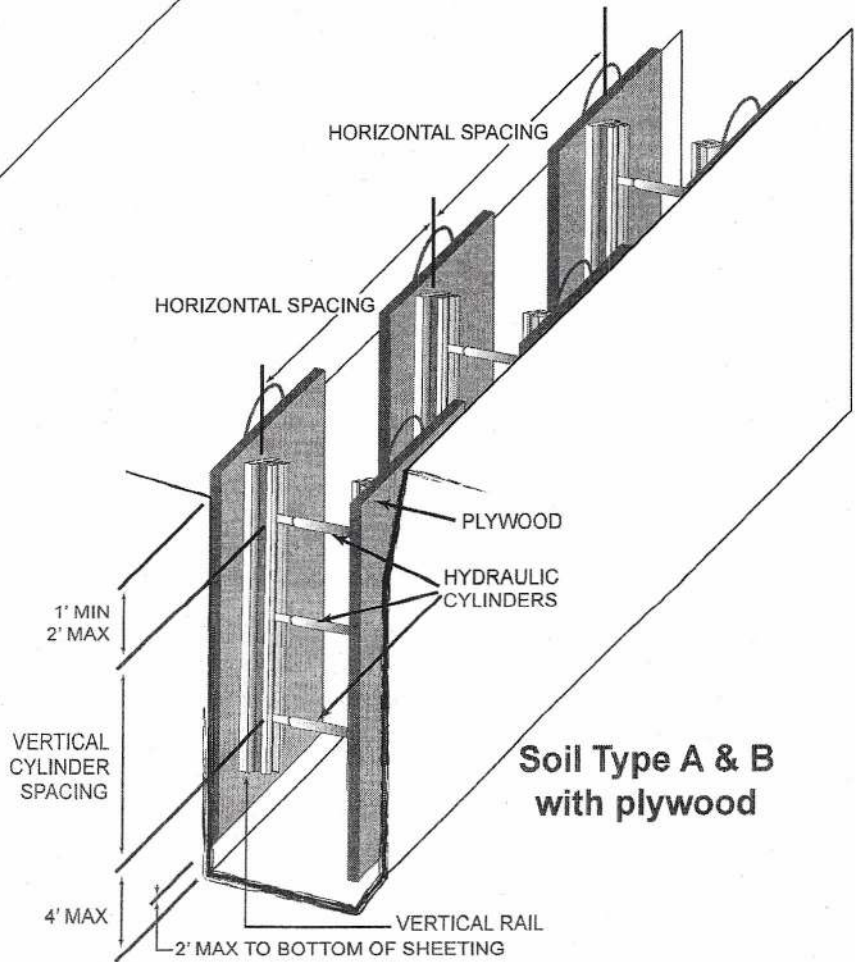

**Soil Type A & B
with plywood**

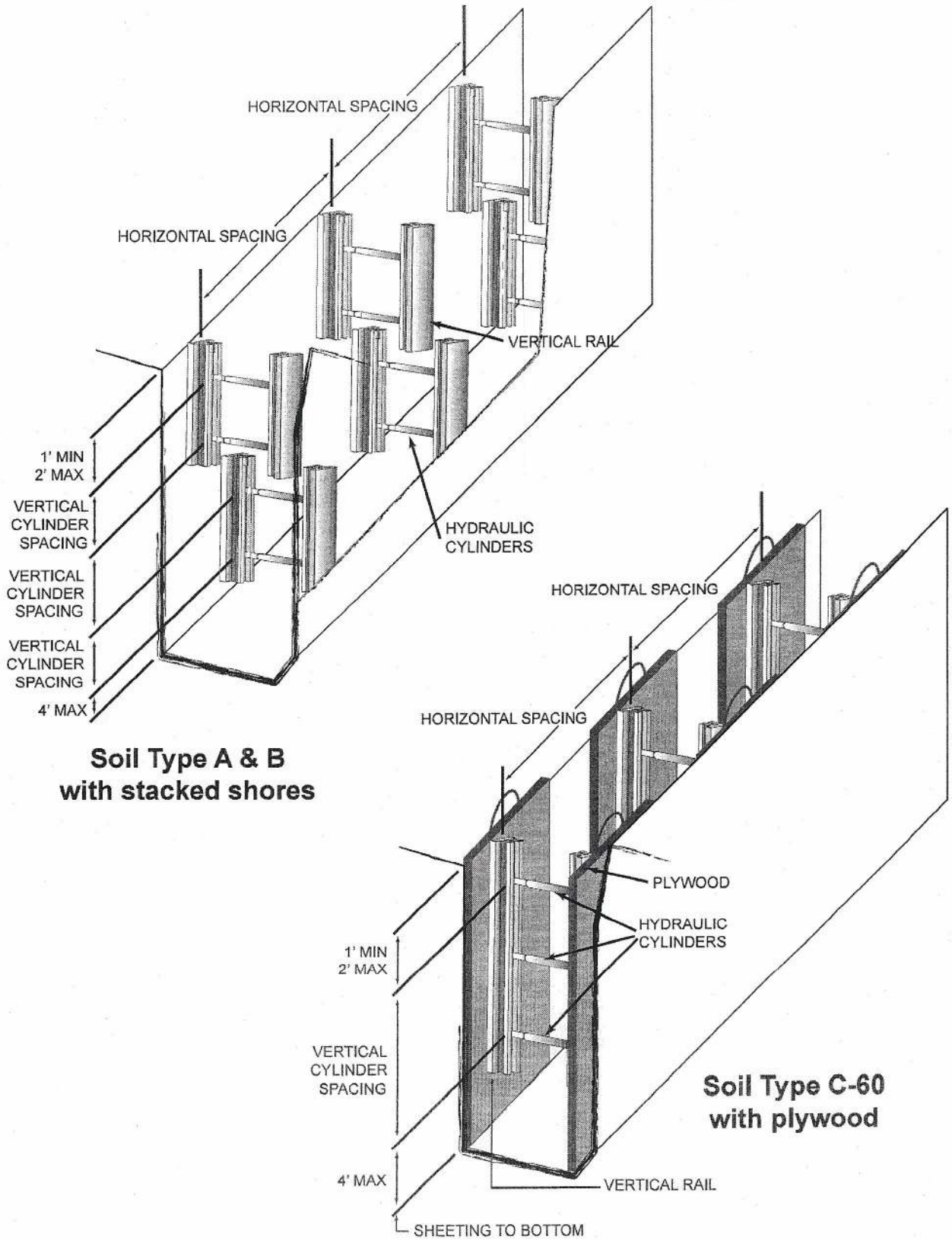

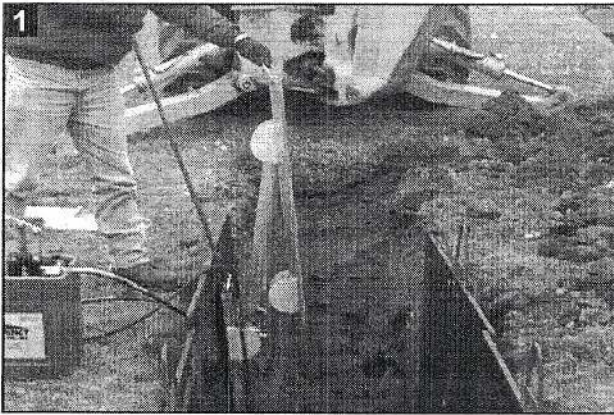

1 Place the shore near the trench edge in the open position with the "cylinder rail" down. Open the valve on the pump can 1/4 turn. Attach the female quick connect fitting on the pump hose to the male fitting on the top cylinder. Put the release tool through the handle on the lower rail with the hook positioned to grab the handle. Fold the shore by pulling the top rail toward you by hand. Lower the shore into the trench with hook.

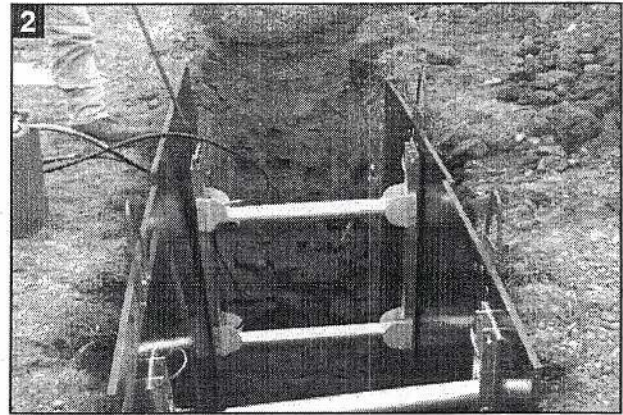

2 Release the top rail and allow shore to completely unfold. The shore will lock itself into open position.

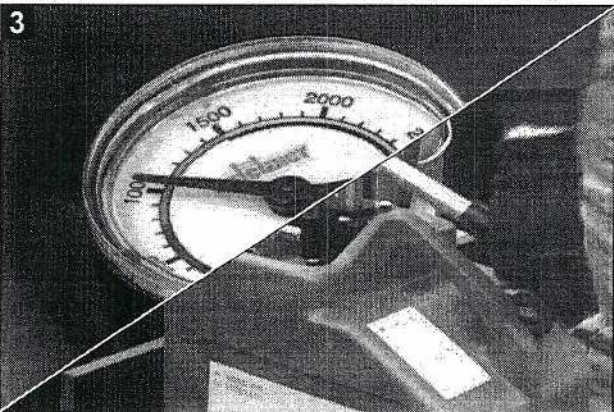

3 While holding the shore at the desired height, close the 1/4 turn release valve on pump can and pump the handle on the can to build pressure between 750-1500 PSI.

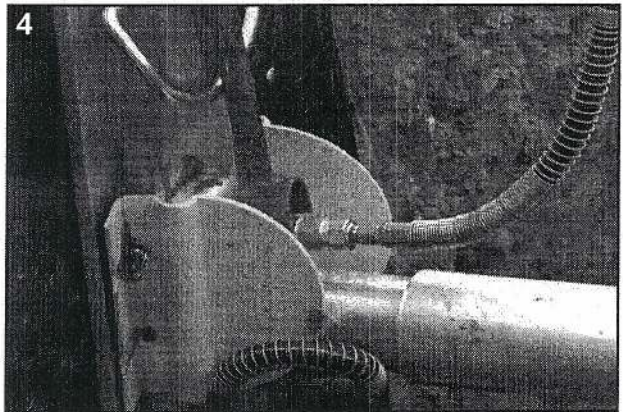

4 To remove the hose, place the release tool flange behind the collar of the quick disconnect fitting. The hook will be toward you. Pull the tool toward yourself, using the hook as a pivot, the hose will come off. After hose is disconnected, clip hose to the top of pump. Open valve on pump and move to the next shore.

CAUTION: Always keep fingers out of the inside channel of rail. The cylinder pivot points can severely cut or pinch when the shore is folded.

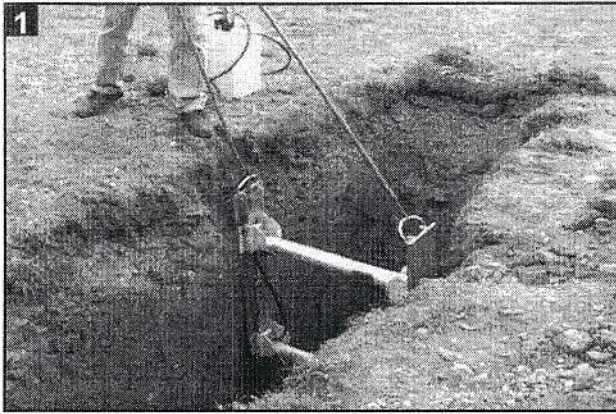

1 To remove the shore, place the removal tool through the handle with the hook facing the trench. Place the end of the tool over the same fitting where hose was hooked.

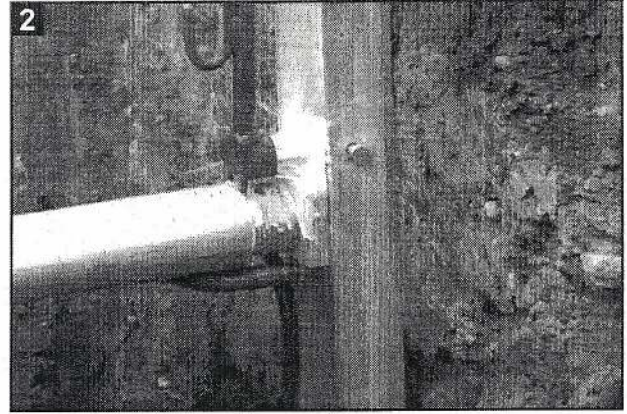

2 Push the tool away from you against the handle. The tool will depress the fitting and release a small amount of fluid.

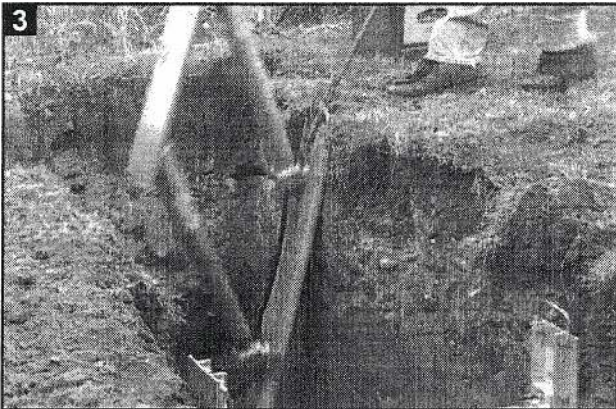

3 Remove from trench by pulling one side with release tool and the other side with the removal hook.



4 The shore will fold as it is pulled out. Remove tools, fold shore flat, and carry to the next installation spot.

TYPE A & B SOILS					
Depth of Trench (ft.)	**Waler Model	Horiz. Cyl. Spacing (ft.)	Max. Vert. Spacing (ft.)	Max. Width of Trench (ft.) (2)	Sheeting (3)
UP TO 10'	6WS, 6WH	5	4'	12'	(4)
	8WS, 8WH	6.0, 7.0	4'	12'	(4)
	12WS3	5	4'	12'	(4)
	12WH3	5.25	4'	12'	(4)
	12WH	8	4'	12'	(4)
	12WHX	10.5	4'	12'	(4)
	16WH3	7.25	4'	12'	(4)
11' TO 15'	6WS, 6WH	5	4'	12'	(5)
	8WS, 8WH	6.0, 7.0	4'	12'	(5)
	12WS3	5	4'	12'	(5)
	12WH3	5.25	4'	12'	(5)
	12WH	8	4'	12'	(5)
	12WHX	10.5	4'	12'	(5)
	16WH4	7.25 (1)	4'	12'	(5)
16' TO 20'	6WS, 6WH	5	4'	12'	(5)
	8WH	7	4'	12'	(5)
	12WS3	5	4'	12'	(5)
	12WH3	5.25	4'	12'	(5)
	12WH	8	4'	12'	(5)
	16WH4	7.25 (1)	4'	12'	(5)

* SEE PAGE 12 FOR NOTES.

Nomenclature for Waler Models:

Prefix = waler length

S = Standard Duty Walers

H = Heavy Duty Walers

X = 2 Cylinders At Maximum Spacing

Suffix = Number Of Cylinders

No Suffix = 2 Cylinders Minimum

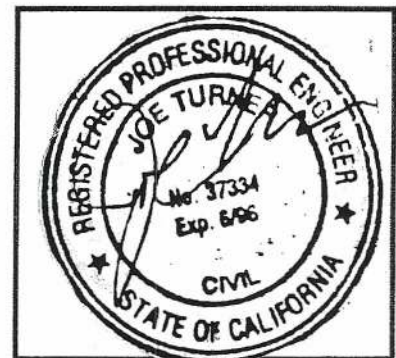

TYPE C-60 SOILS					
Depth of Trench (ft.)	**Waler Model	Horiz. Cyl. Spacing (ft.)	Max. Vert. Spacing (ft.)	Max. Width of Trench (ft.) (2)	Sheeting (3)
UP TO 10'	6WS, 6WH	5	4'	12'	(5)
	8WS, 8WH	6.0, 7.0	4'	12'	(5)
	12WS3	5	4'	12'	(5)
	12WH3	5.25	4'	12'	(5)
	12WH	8	4'	12'	(5)
	12WHX	10.5	4'	12'	(5)
	16WH3	7.25	4'	12'	(5)
11' TO 15'	6WS, 6WH	5	4'	12'	(6)
	8WS, 8WH	6.0, 7.0	4'	12'	(6)
	12WS3	5	4'	12'	(6)
	12WH3	5.25	4'	12'	(6)
	12WH	8	4'	12'	(6)
	12WHX	10.5	4'	12'	(6)
	16WH4	7.25 (1)	4'	12'	(6)
16' TO 20'	6WS, 6WH	5	4'	12'	(7)
	8WH	7	4'	12'	(7)
	16WH4	7.25 (1)	4'	12'	(7)

* SEE PAGE 13 FOR NOTES.

Nomenclature for Waler Models:

Prefix = waler length

S = Standard Duty Walers

H = Heavy Duty Walers

X = 2 Cylinders At Maximum Spacing

Suffix = Number Of Cylinders

No Suffix = 2 Cylinders Minimum



TYPE C-80 SOILS						
Depth of Trench (ft.)	**Waler Model	Horiz. Cyl. Spacing (ft.)	Max. Vert. Spacing (ft.)	Max. Width of Trench (ft.) (2)	Sheeting (3)	
UP TO 10'	6WS, 6WH	5	4'	12'	(7)	(8)
	8WH	7.0	4'	12'	(7)	(8)
	12WH3	5.25	4'	12'	(7)	(8)
	12WH	8	4'	12'	(7)	(8)
	12WHX	10.5	4'	12'	(7)	(8)
	16WH3	7.25	4'	12'	(7)	(8)
11' TO 15'	6WH	5	4'	12'	(7)	(8)
	8WH	6.0, 7.0	4'	12'	(7)	(8)
	16WH4	7.25 (1)	4'	12'	(7)	(8)
16' TO 20'	6WH	5	4'	12'	(7)	(8)

NOTES:

- Utilize two - Efficiency's 2 in. diameter Hydraulic Cylinders. Trenches wider than 9'4" (112") require Efficiency's Steel Oversleeves, extending the full, collapsed length.
- Utilize Efficiency's 2 in. diameter Hydraulic Cylinders with standard or heavy duty extension system as required for desired excavation width.
- Plywood sheeting shall consist of 1.125 in. CDX plywood or .75 in. 14-ply Arctic Birch. Timber sheeting shall be #1 Douglas Fir with minimum Fb = 1,500 psi or equal.*
- Provide 4 ft. wide plywood or 2x8 ft. timber sheeting at 2'0" O.C. if raveling or sloughing of excavation face appears likely to occur. The bottom of the sheeting shall extend to within 2 ft. of the bottom of the excavation.
- Provide 4'0" wide plywood or 2x8 ft. timber sheeting at close spacing.
- Provide 2x8 ft. timber sheeting at close spacing to bottom of excavation.
- Provide 3x8 ft. timber sheeting at close spacing to bottom of excavation.
- The max-distance from the bottom of the excavation to the bottom waler shall be 2½ ft. unless the sheeting is over-driven 1 ft. If over-driven, the maximum distance to the bottom waler shall be 4 ft.

* See "L." of "General Information" for alternate sheeting.

Nomenclature for Waler Models:

Prefix = waler length

S = Standard Duty Walers

H = Heavy Duty Walers

X = 2 Cylinders At Maximum Spacing

Suffix = Number Of Cylinders

No Suffix = 2 Cylinders Minimum

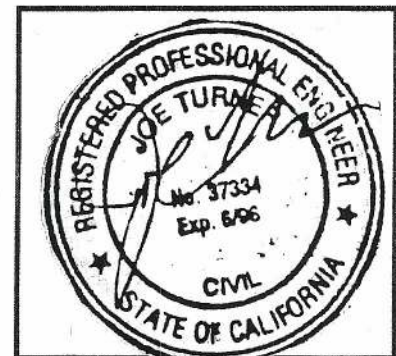

Hydraulic Aluminum Shoring - Tabulated Data

Waler Rail Specification Sheet

Section Properties

Standard Rail

Heavy Duty Rail

Material	Aluminum	Aluminum
Alloy	6061-T6	6061-T6
Area	4.87 in ²	9.76 in. ²
Weight	5.84 plf	11.72 plf
Section Modulus - Top (leg side)	3.62 in. ³	14.50 in. ³
Section Modulus - Bottom (blade side)	4.52 in. ³	14.40 in. ³
Equivalent Timber Size * (#2 Douglas Fir)	8x10 (on edge)	12x16 (on edge)

Standard Vertical Rail

Heavy-Duty Vertical Rail

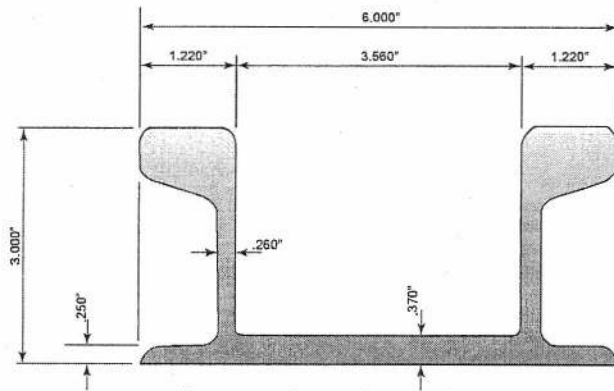
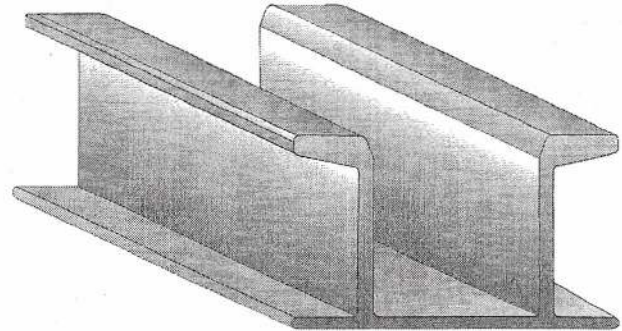
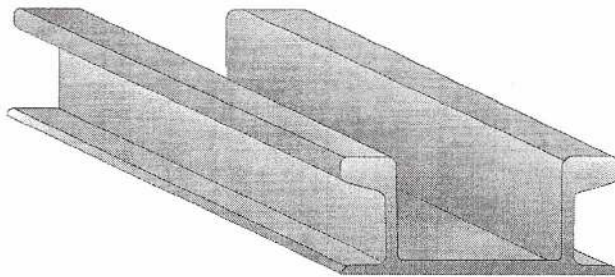

Cross Section of Standard Waler

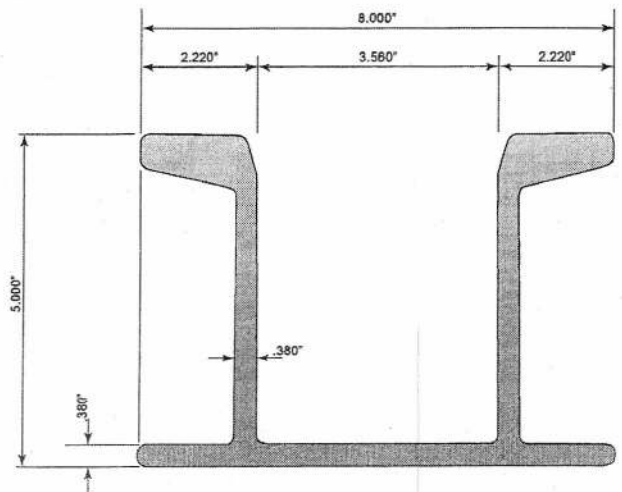

Cross Section of Heavy-Duty Waler

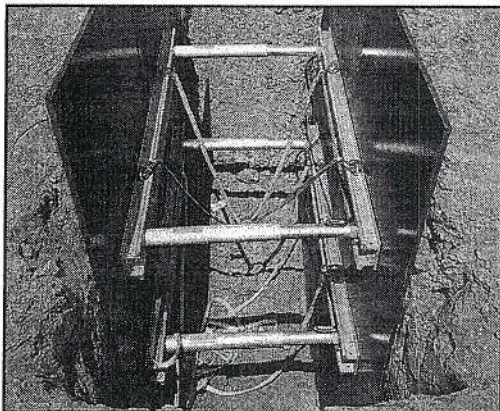
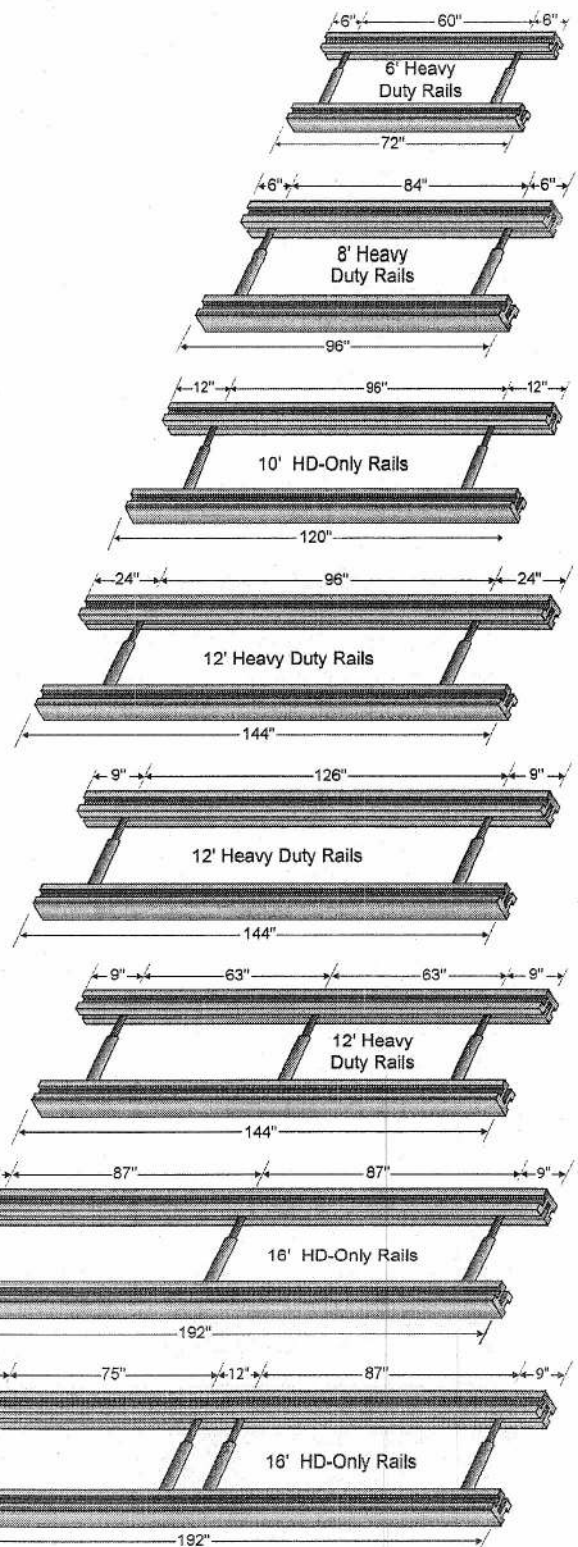
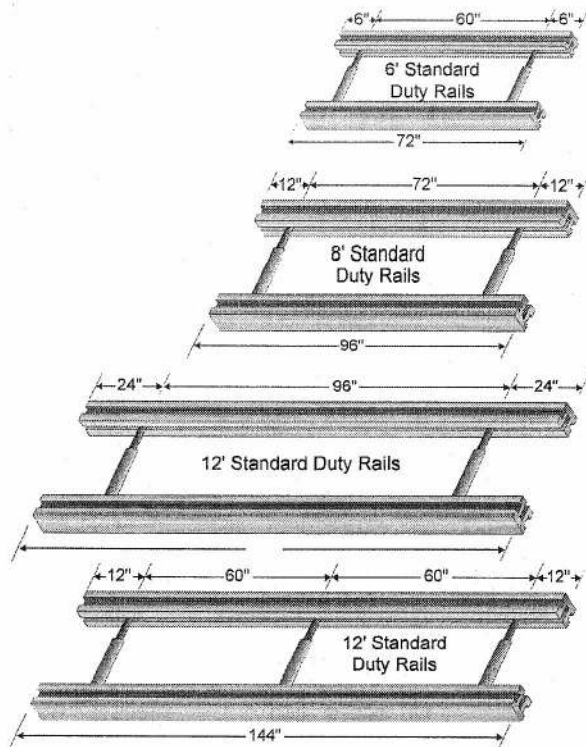

For Installing walers into trench:

1. Attach sling to the lower waler set.
2. Lower the waler set stacked one on top of the other.
3. Lower the walers into the trench until the top set of walers are in place.
4. Pump the top cylinders out until the pump gage is in the green zone. Check pump gage to make sure pressure is holding.
5. Lower the bottom walers into place and repeat step 4.

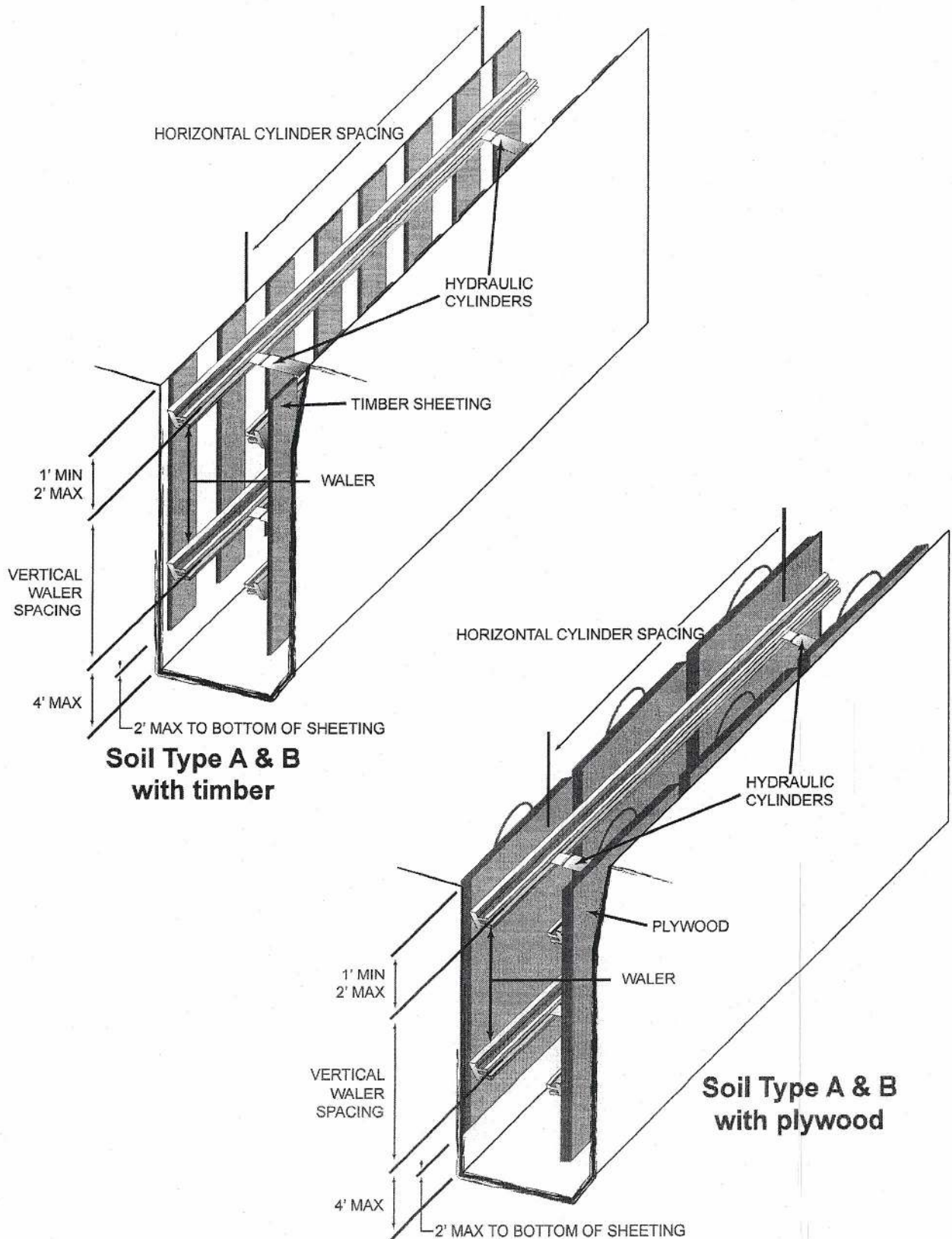

Hydraulic Aluminum Shoring - Tabulated Data

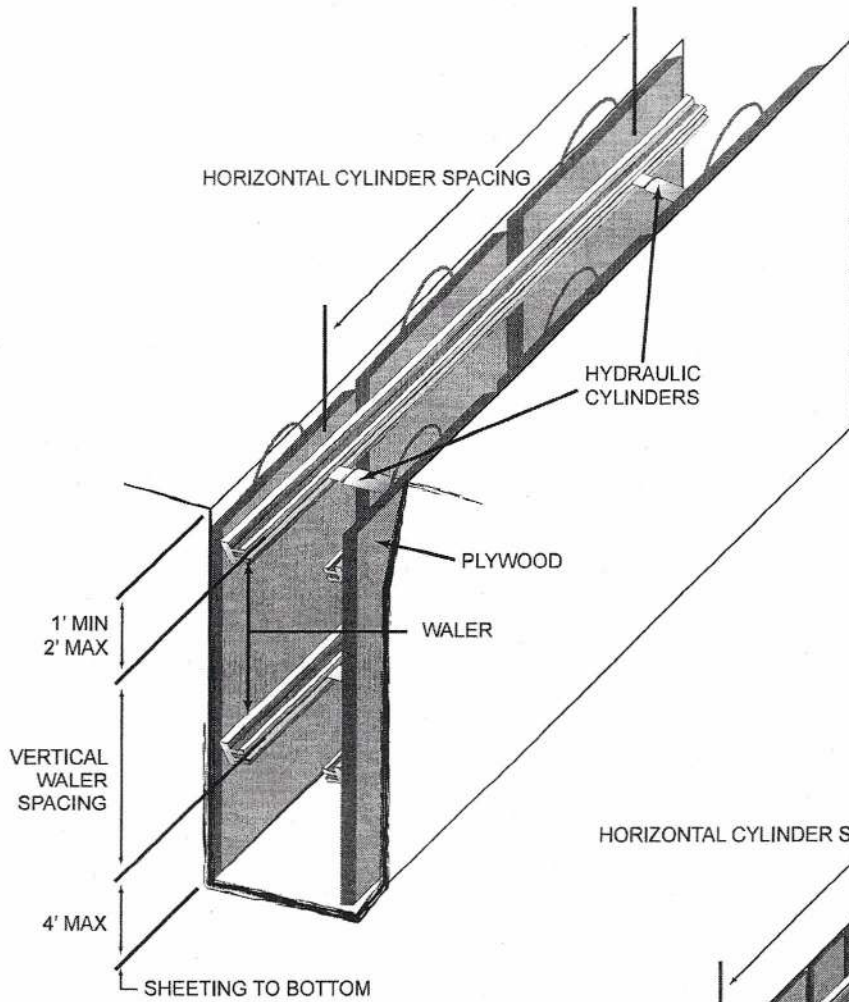

**Soil Type C-60
with plywood**

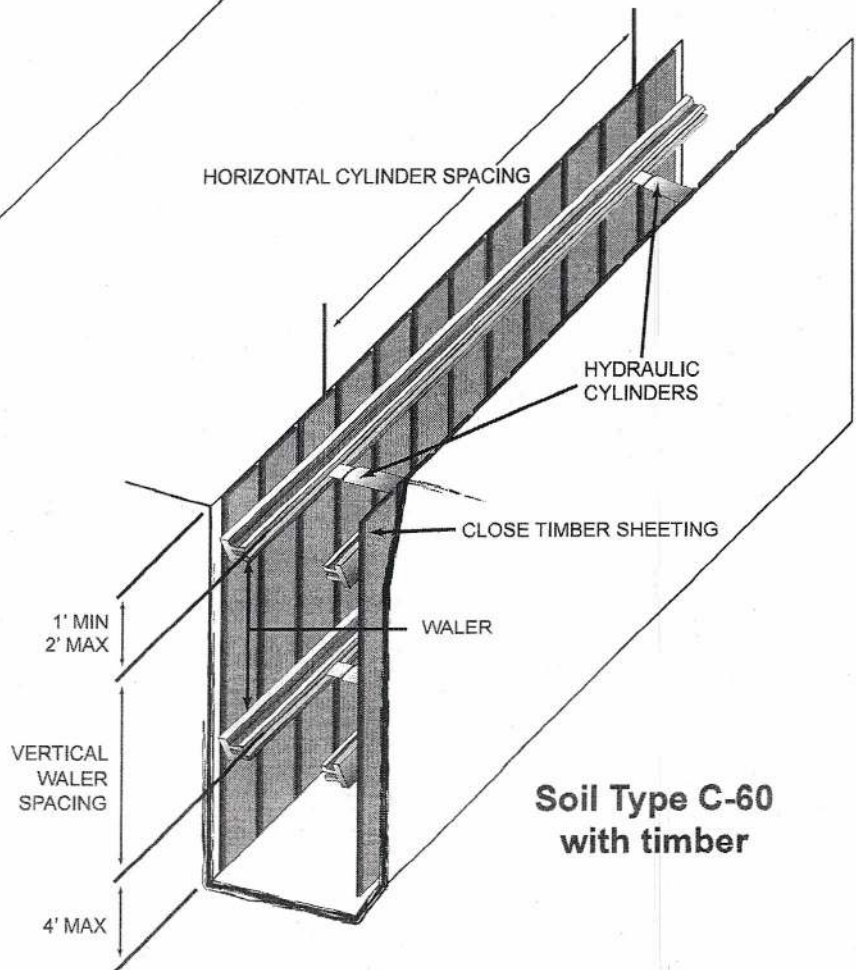

**Soil Type C-60
with timber**

Hydraulic Aluminum Shoring - Tabulated Data