

EFFICIENCY PRODUCTION, INC.

AMERICA'S TRENCH BOX BUILDER™

Hydraulic Aluminum Shoring

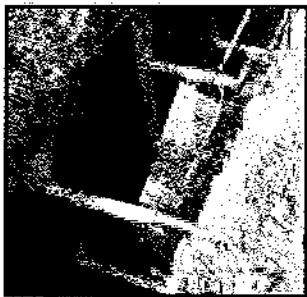
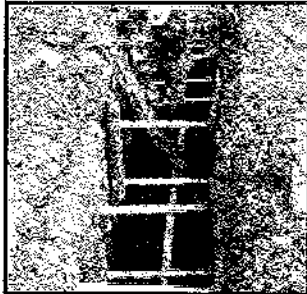

EFFICIENCY PRODUCTION, INC.
Hydraulic Shoring Tab Data 2010

Tabulated Data

Effective January 4, 2010

Revised: February 26, 2013 - with CHANGE TWO



AMERICA'S TRENCH BOX BUILDER™
America's Trench Box Builder™

www.encyproduction.com

800-552-8800

517-676-8800

Fax: 517.676.0373



America's trench box builder

Hydraulic Shoring Tab Data

Table of Contents

Efficiency Production Inc.
685 Hull Rd., Mason, MI 48854
800-552-8800 • 517-676-8800 • Fax: 517.676.0373
www.efficiencyproduction.com

General Information1

Revised: February 26, 2013 - with CHANGE TWO

Soil Classification.....2

Vertical Shoring and Waler System Notes4

Vertical Shoring System

System Selection Guide5

Vertical Rail Specifications 6-7

Installation Examples..... 8-9

Installation Guide.....10

Removal Guide..... 11

Waler Shoring System

Waler Selection Guide 12-14

Revised: February 26, 2013 - with CHANGE TWO

Waler Rail Specifications 15-16

Installation Examples..... 17-19

Hi-Clearance Shores 20-23

End Shores..... 24-25

Revised: February 8, 2013 - with CHANGE ONE

Additional Certifications.....Appendix A

Hydraulic Aluminum Shoring - Tabulated Data

As Manufactured By Efficiency Production, Inc.

General Information for Using Hydraulic Aluminum Shoring

This tabulated data is a general set of guidelines and tables to assist the competent person in selecting a safety system and the proper shoring or shielding equipment. The competent person has sole responsibility for job site safety and the proper selection and installation and removal of the shoring or shielding equipment.

This tabulated data is not intended to be used as a job specific excavation safety plan, but shall be used by the competent person to supplement his training, his experience and his knowledge of the job conditions and soil type.

1. The hydraulic aluminum shoring system tabulated data is based on the OSHA Safety requirements defined in 29 CFR, Part 1926, Subpart P - Excavations and Trenches.
2. This data is to be used by a soils engineer, or a competent person. The competent person shall be experienced and knowledgeable of trenching and excavation procedures, these of hydraulic shoring systems, soils identification, and the OSHA standards.
 - a. A trained competent person shall: supervise all excavation operations; ensure that all personnel are working in safe conditions; and have thorough knowledge of this tabulated data. The competent person shall have the authority to stop work when it is unsafe for workers to enter an excavation.
 - b. All personnel shall be trained in correct excavation procedures, proper use of the protective system and all safety precautions.
 - c. Excavations and protective systems shall be inspected a minimum of once each working day and whenever there is a change of soil, water, or other job site conditions.
 - d. All lifting and pulling equipment, including cables, slings, chains, shackles and safety hooks shall be evaluated for suitability and capacity, and shall be inspected for damage or defects prior to use.
3. The competent person shall continually monitor the excavation for signs of deterioration such as seepage of water or flowing soil into the excavation. Promptly dewater any accumulated water and reassess the trench for safety. Changing soil conditions may require adjustments to the shoring system.
 - a. All installation and removal of shoring and shielding shall be from above ground only.
 - b. Do not allow personnel to enter an excavation that is not properly shored, shielded or sloped.
 - c. Personnel shall always work within the shoring and shielding. Personnel shall not stand on the edge of an un-shored excavation.
 - d. All personnel shall enter and exit excavations only within shielded or shored areas.

NEXT PAGE

Hydraulic Aluminum Shoring - Tabulated Data

4. The tabulated data shall only be used for those soil conditions indicated. The data is not considered adequate when loads imposed by structures, equipment, traffic, or stored materials adjacent to the trench exceed the assumed design surcharge loads of 20,000 pounds, or the imposed load of a 2 ft. spoil pile located less than 2 ft. from the edge of the excavation. An engineered shoring design is required for conditions other than those assumed in the tables.
5. When only the lower portion of a trench is to be shored and the remaining portion is benched or sloped at an angle steeper than three horizontal to one vertical (3H:1V), the shoring members shall be selected from the tabulated data for use at a depth which is determined from the top of the overall trench and not the toe of the sloped portion.
6. The faces of the excavation shall be straight and near vertical. Shoring members must bear on firm soil or solid filler.
7. Trenches shall be kept dry and free of water at all times.
8. Vertical and/or horizontal lateral loads shall not be applied to the hydraulic cylinders.
9. Once cylinders are pressurized between 750 - 1500 PSI, the soil should not give and reduce the pressure within the cylinder.
10. Whole length of the trench can be shored within maximum of 4 ft. of the ends. Competent Person may decrease distance as conditions merit.
11. Plywood sheeting shall be 1.125" thick CDX or .75" thick, 14 ply, arctic birch. Note that the plywood is not intended as a structural member, but only for the prevention of local raveling or sloughing of the trench face between the shores.
12. When plywood sheeting is used, it shall extend to the top of the excavation and to within 2 ft. of the bottom of the excavation in Type A & B soils, and to the bottom of the trench in Type C-60 soils. See typical installation diagrams.
13. Plywood sheeting, as referenced throughout this tabulated data may be substituted with other engineered sheeting, such as (1) 0.75 in. thick, 14 ply, white birch - Finland Form; also known as Euro Form, Metsaform, Wisiform and Chudoform, (2) 1.125 in. thick soft plywood, (3) 0.25 in. thick steel plate, with a min. yield strength (fy) of 50,000 psi., (4) 0.3125 in. minimum thickness steel plate, with a min. yield strength (fy) of 36,000 psi., (5) 0.75 in. thick, 13 ply, plywood consisting of both hardwood and soft wood veneers, known as OMNI FORM, (6) Efficiency 2-3/4" thick or 4-9/16" thick extruded aluminum Build-A-Box or XLAP panels, (7) 0.75 in. thick Sentry Panel. Any of these sheets may be used in any combination in the same trench, either on same side or on the opposite side.

Revised: February 26, 2013 - CHANGE TWO

Classification of Soil Types

The soil descriptions for OSHA Type "A", "B", & "C" Soils are based on Appendix A to OSHA Subpart P of 29CFR Part 1926, "Excavations and Trenches". The Type "C-60" Soil referred to in Efficiency's Tabulated Data represents a more stable soil condition than the Type "C" described in Appendix A.

Type "A" Soil - Equivalent weight effect of **25 PSF** per foot of depth.

Description: Cohesive soil (i.e., clay, silty clay, sandy clay, clay loam) with an unconfined compressive strength of 1.5 TSF (tons per square foot) or greater; or cemented soils such as caliche and hardpan. No soil is Type A if the soil is fissured; subject to vibration from heavy traffic, pile driving or similar effects; has been previously disturbed; or part of a sloped, layered system where the layers dip into the excavation on a slope of four horizontal to one vertical (4H:1V) or greater.

Type "B" Soil - Equivalent weight effect of **45 PSF** per foot of depth.

Description: Cohesive soil with an unconfined compressive strength greater than .5 TSF but less than 1.5 TSF; and granular cohesionless soils including angular gravel, silt, silt loam, sandy loam, and in some cases, silty clay loam and sand clay loam; previously disturbed soils except those which would otherwise be classed as Type C; soil that meets requirements for Type A, but is fissured or subject to vibration; dry rock that is unstable; and material that is part of a layered system where layers dip into the excavation on a slope less steep than four horizontal to one vertical (4H:1V), but only if the material would otherwise be classified as Type B.

Type "C-60" Soil - Equivalent weight effect of **60 PSF** per foot of depth.

Description: Soft cohesive to moist soil with an unconfined compressive strength less than .5 TSF; moist cohesive soil or moist dense sand which is not flowing or submerged. When cut with near vertical side walls, soil can stand with unsupported vertical sidewalls long enough for shoring installation. (see "1.c.")

Type "C-80" Soil - Equivalent weight effect of **80 PSF** per foot of depth.

Description: Cohesive soil with an unconfirmed compressive strength of .5 TSF or less; granular soils including gravel, sand, and loamy sand; submerged soil or soil from which water is freely seeping; submerged rock that is not stable; and material in a sloped, layered system where the layers dip into the excavation on a slope of four horizontal to one vertical (4H : 1V) or steeper.

Vertical Hydraulic Shoring System:

- A. Trenches exceeding 8 ft. in length will have a minimum of 3 shores spaced according to the tables. In trenches shorter than 8 ft. in length, 2 sets of vertical shores are required at the horizontal spacing indicated in the tables.
- B. For trenches 6 ft. in depth, vertical shoring shall consist of a minimum of one single cylinder rail. The bottom or single cylinder shall be positioned no more than four ft. from the bottom of the trench and there shall be no more than two ft. from the top of the trench to the top or single cylinder. See typical installation diagrams.
- C. For trenches 6 to 10 ft. in depth, vertical shoring shall consist of a minimum of two hydraulic cylinders in each vertical plane. See typical installation diagrams.
- D. Single (cylinder) shores may be substituted for two-cylinder vertical shores. The cylinder spacing tables (page 4, page 9-top figure) must be followed.
- E. Do Not butt rails back to back across an excavation.
- F. This standard applies to both standard and rescue shores

Hydraulic Water Shoring System:

- A. Timber sheeting shall be #1 Douglas Fir with a minimum Fb = 1,500 psi, or equivalent.
- B. When timber sheeting is used in Type C soil, the maximum distance from the bottom of the excavation to the bottom wale shall be 2' - 6" unless the sheeting is over-driven into the bottom of the trench a minimum of 1 ft. If over-driven, the maximum distance to the bottom wale shall be 4 ft.. See typical installation diagrams.
- C. A minimum of 2 sets of waler rails shall be used, one above the other. A single set of waler rails does not provide adequate protection.
- D. When double hydraulic cylinders are required at one location, both cylinders must be pressurized the same to prevent the possible failure of a single cylinder.
- E. Walers shall be placed end to end where more than one is used in the horizontal direction.

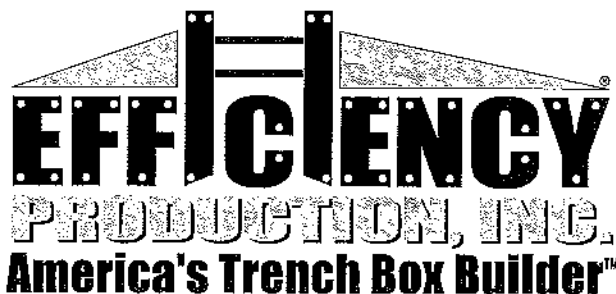

This tabulated data is applicable to any vertical hydraulic shoring system or hydraulic water shoring system manufactured by Efficiency Production, Inc. or Safe-T-Shore.

Depth of Trench (ft.) SEE NOTE 5	Max. Horizontal Shoring Spacing (ft.) SEE NOTE 6	Maximum Vertical Cylinder Spacing (ft.) SEE NOTE 1	Max. Width of Trench (ft.) Up to 12 ft. - SEE NOTE 1, 2 12-15 ft. - SEE NOTE 2, 7	Sheeting SEE NOTE 2 and:
TYPE "A" SOIL				
Up To 10'	8'	4'	12' to 15'	3
11' To 15'	8'	4'	12' to 15'	3
16' To 20'	8'	4'	12' to 15'	3
21' To 25'	8'	4'	12' to 15'	3
TYPE "B" SOIL				
Up To 10'	8'	4'	12' to 15'	3
11' To 15'	7'	4'	12' to 15'	3
16' To 20'	6'	4'	12' to 15'	3
21' To 25'	5'	4'	12' to 15'	3
TYPE "C-60" SOIL				
Up To 10'	6'	4'	12' to 15'	3
11' To 15'	5'	4'	12' to 15'	4
16' To 20'	4'	4'	12' to 15'	4
21' To 25'	3'	4'	12' to 15'	4
TYPE "C-80" SOIL				
N/A	N/A	N/A	N/A	N/A

NOTES:

- Utilize Efficiency's 2 in. diameter hydraulic cylinders with standard or heavy duty extension system as required for desired excavation width. Trenches wider than 9'-4" up to 12' (112"-144") require Efficiency's Steel Oversleeves that extend the full, collapsed width; or universal one-piece aluminum extension. Trenches 12'-1" up to 15' (145"-180") wide require Efficiency's Steel Oversleeves that extend the full, collapsed width.
- Plywood sheeting shall consist of 1.125 in. CDX plywood or .75 in., 14 ply Arctic Birch.*
- Plywood sheeting required if raveling or sloughing is likely to occur. (see installation diagrams)*
- Plywood sheeting shall be used.*
- Material can stand with unsupported vertical sidewalls long enough for shoring installation.
- Vertical shoring shall be Efficiency's Standard or Heavy Duty vertical rail sections. (see pg 6).
- Extra Heavy Duty Steel-Oversleeve Extensions Required.
- Applies to all 2 in. hydraulic cylinders, standard or with Positive Locking Device (Rescue Shores).

* See [13] of "General Information" for alternate sheeting.

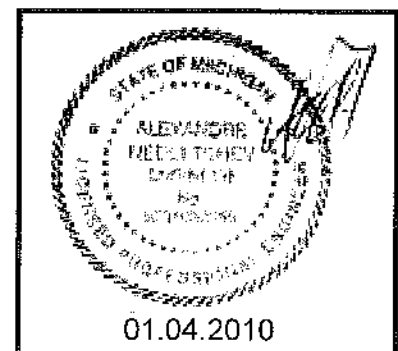

Vertical Rail Specification Sheet

Section Properties

	Standard Rail	Heavy Duty Rail
Material	Aluminum	Aluminum
Alloy	6061-T6	6061-T6
Area	2.45 in.	3.47 in. ²
Weight	2.94 plf	4.17 plf
Section Modulus - Top (leg side)	$S_x=0.44 \text{ in.}^3$	$S_x=1.25 \text{ in.}^3$
Section Modulus - Bottom (blade side)	$S_x=1.29 \text{ in.}^3$	$S_x=2.38 \text{ in.}^3$
Equivalent Timber Size * (#2 Douglas Fir)	3x10 (flat)	4x10 (flat)

Standard Vertical Rail

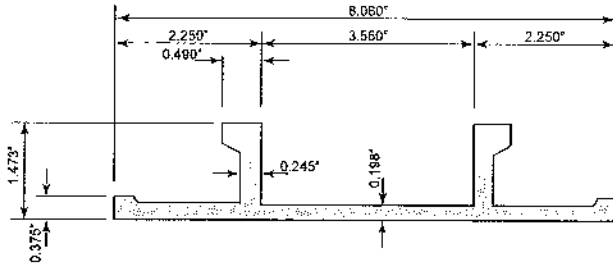
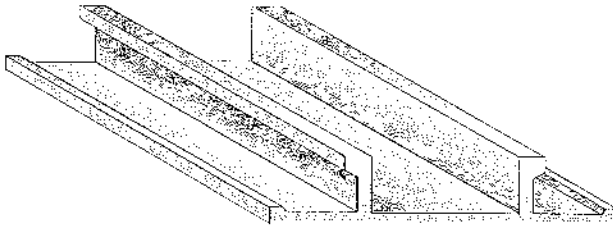

Cross Section of Standard Vertical Rail

Heavy-Duty Vertical Rail

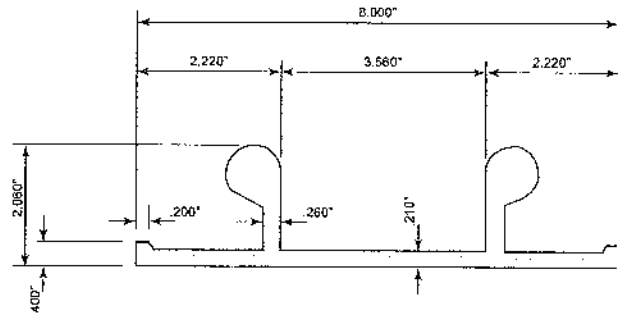
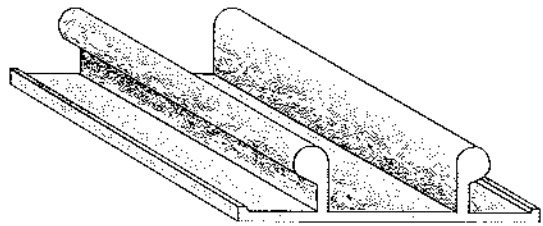

Cross Section of Heavy-Duty Vertical Rail

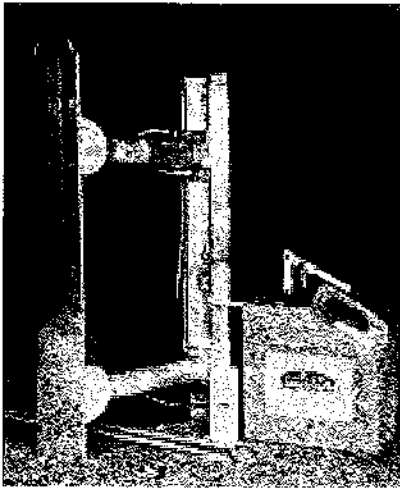

Vertical shore (w/ opt. finger guards), tools, plastic pump can, and fluid.

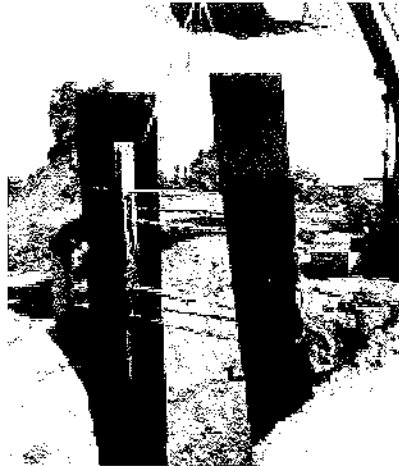

Rails may be bolted to Finform, etc. (See pg. 1 for alternate sheeting)

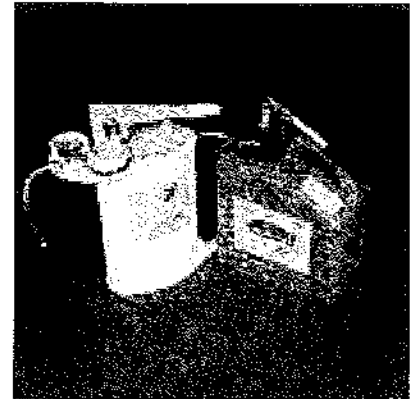

5 gal. metal pump can (left), and 5 gal plastic pump can (right).

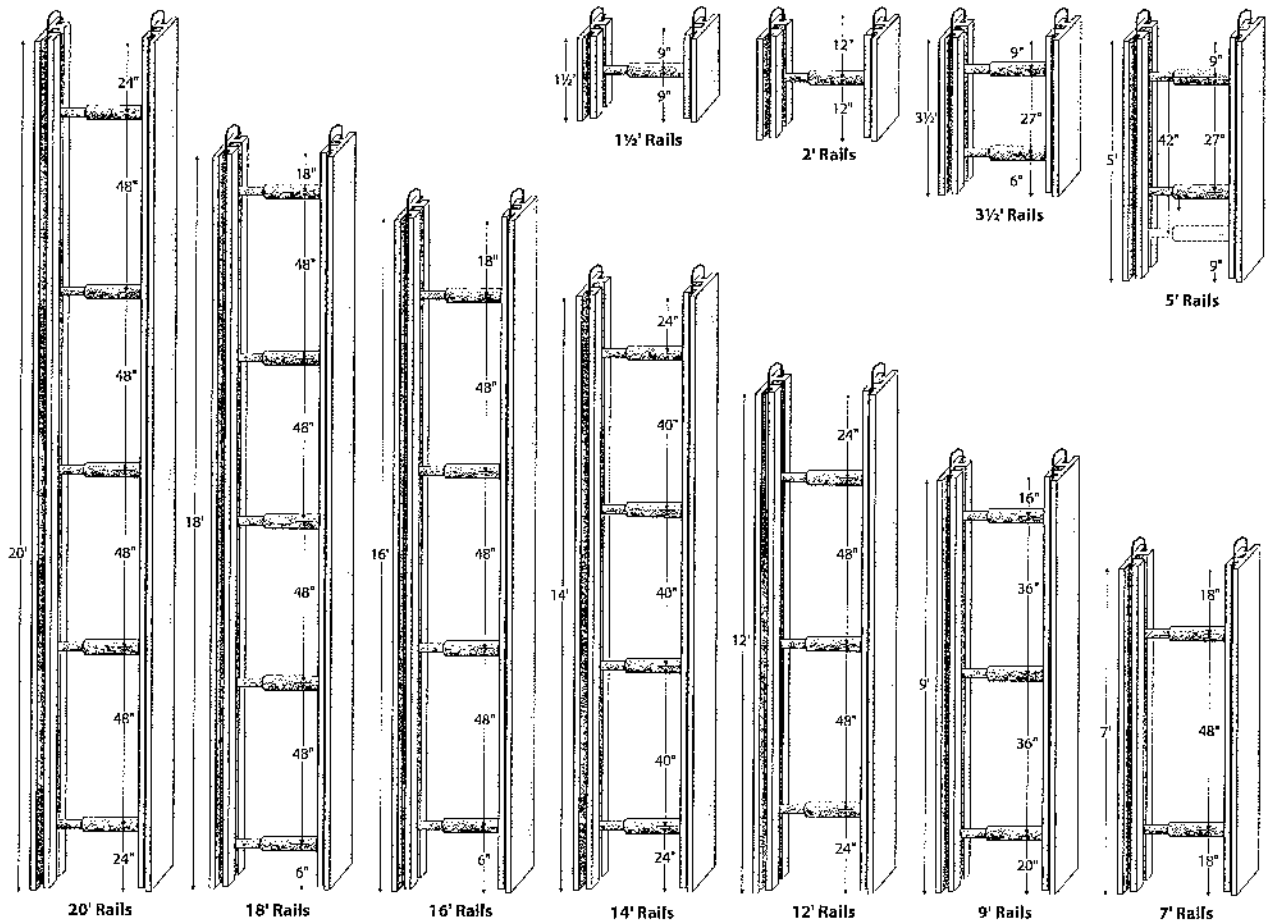

HYDRAULIC VERTICAL SHORING

(Dimensions are taken from the cylinder's center lines)

Hydraulic Aluminum Shoring - Tabulated Data

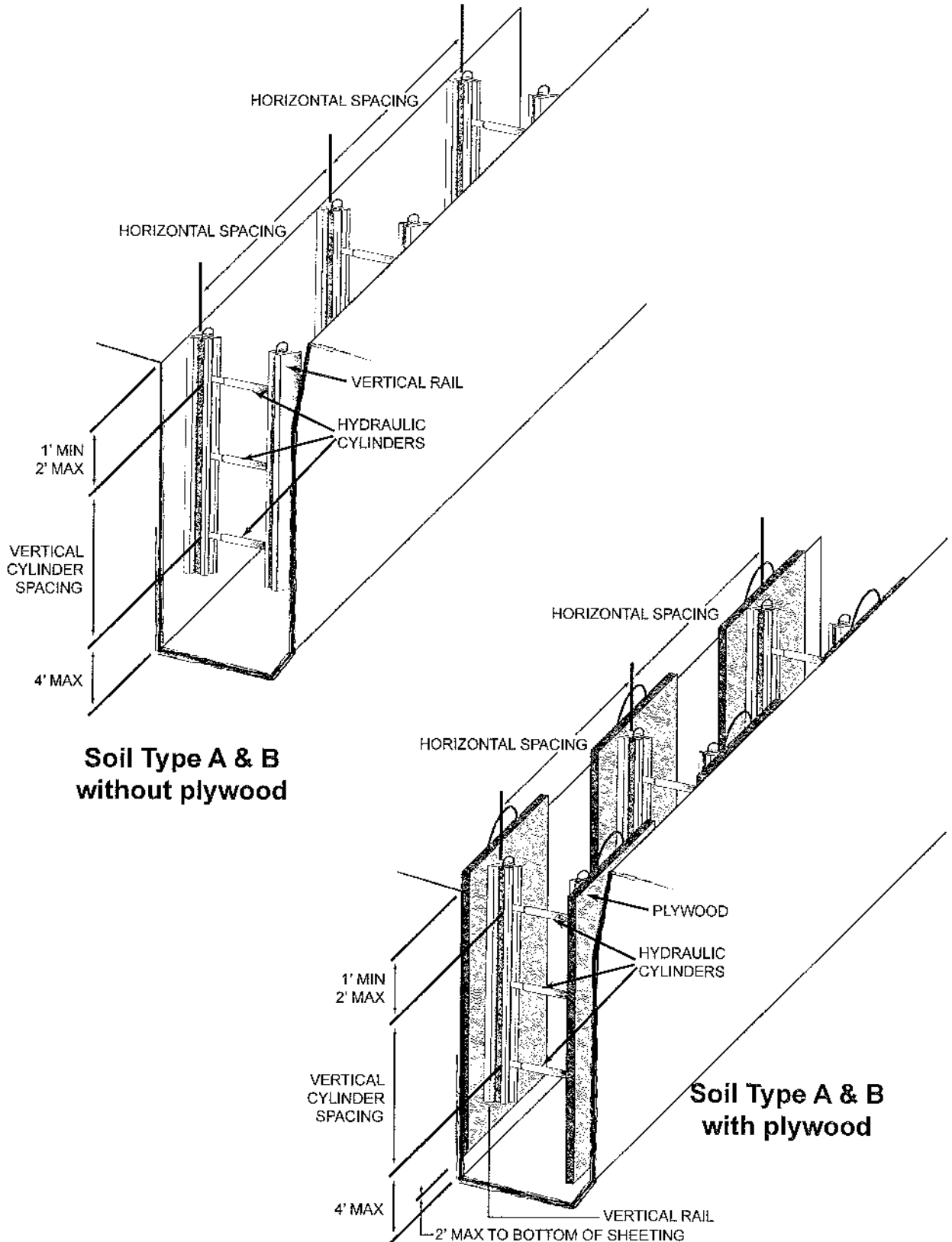

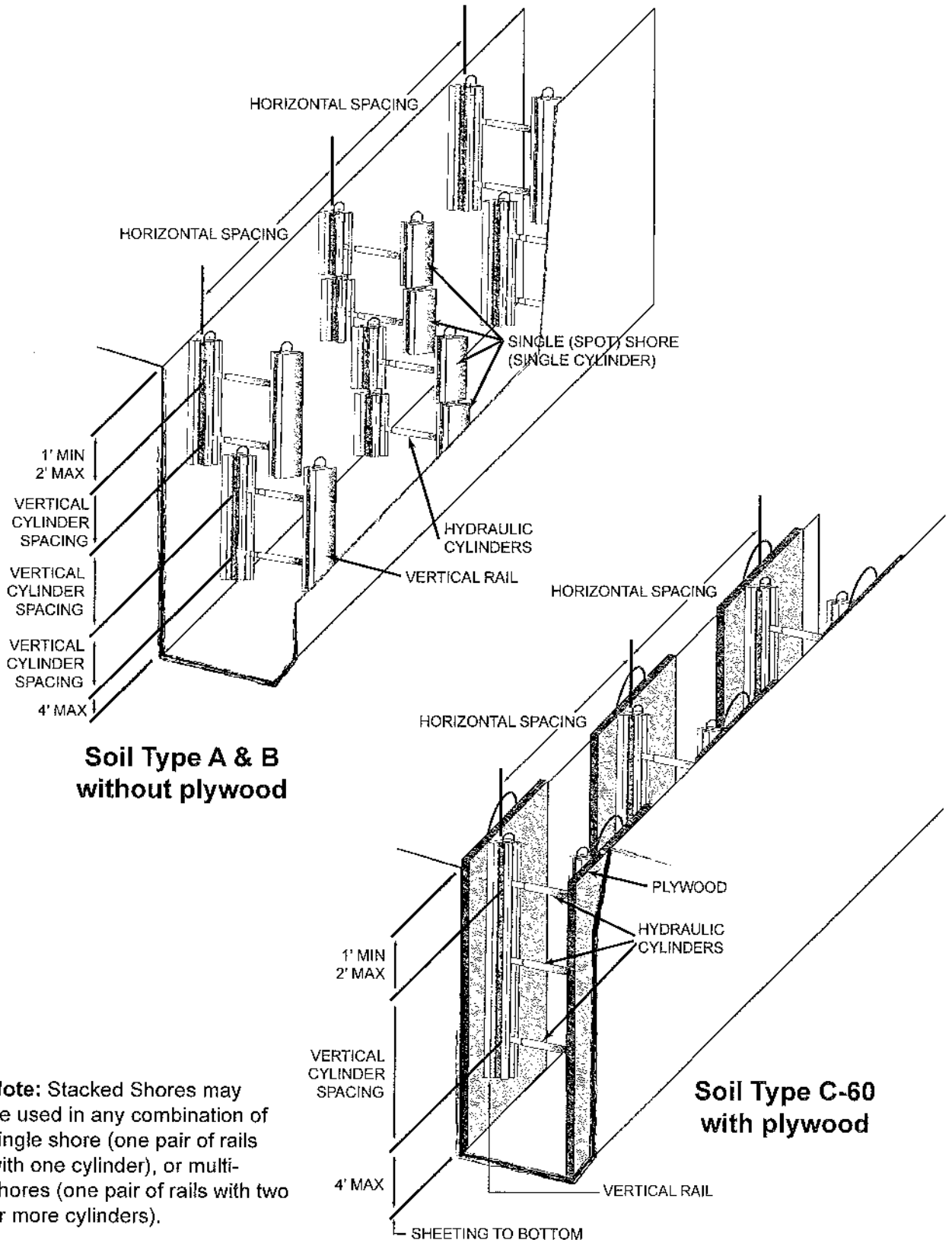

**Soil Type A & B
without plywood**

**Soil Type C-60
with plywood**

Note: Stacked Shores may be used in any combination of single shore (one pair of rails with one cylinder), or multi-shores (one pair of rails with two or more cylinders).



1 Place the shore near the trench edge in the open position with the "cylinder rail" down. Open the valve on the pump can 1/4 turn. Attach the female quick connect fitting on the pump hose to the male fitting on the top cylinder. Put the release tool through the handle on the lower rail with the hook positioned to grab the handle. Fold the shore by pulling the top rail toward you by hand. Lower the shore into the trench with hook.



2 Release the top rail and allow shore to completely unfold. The shore will lock itself into open position.

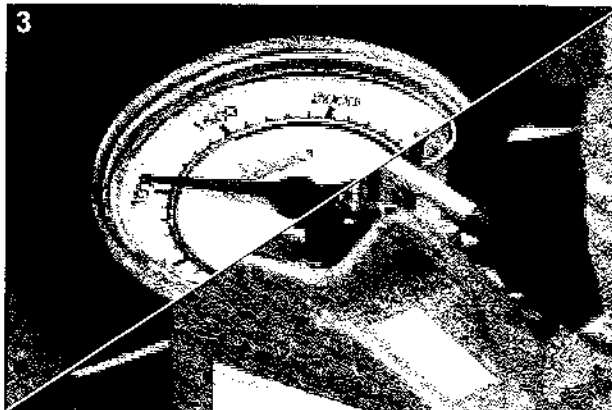

3 While holding the shore at the desired height, close the 1/4 turn release valve on pump can and pump the handle on the can to build pressure between 750-1500 PSI.



4 To remove the hose, place the release tool flange behind the collar of the quick disconnect fitting. The hook will be toward you. Pull the tool toward yourself, using the hook as a pivot, the hose will come off. After hose is disconnected, clip hose to the top of pump. Open valve on pump and move to the next shore.

CAUTION: Always keep fingers out of the inside channel of rail. The cylinder pivot points can severely cut or pinch when the shore is folded.

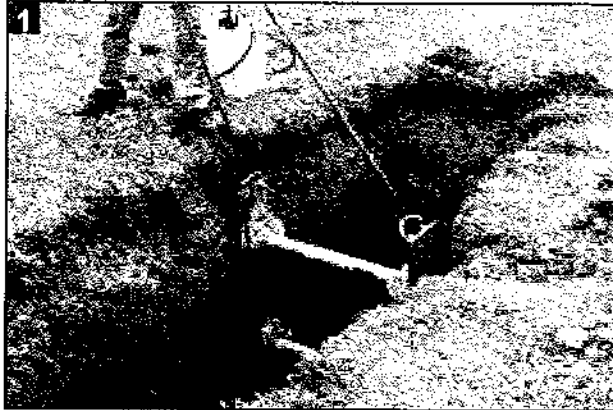

1 To remove the shore, place the removal tool through the handle with the hook facing the trench. Place the end of the tool over the same fitting where hose was hooked.



2 Push the tool away from you against the handle. The tool will depress the fitting and release a small amount of fluid.

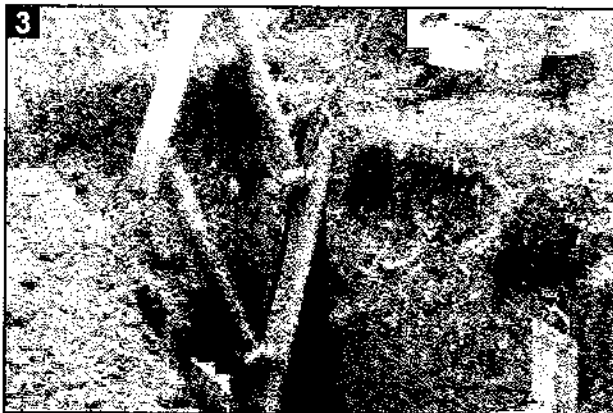

3 Remove from trench by pulling one side with release tool and the other side with the removal hook.

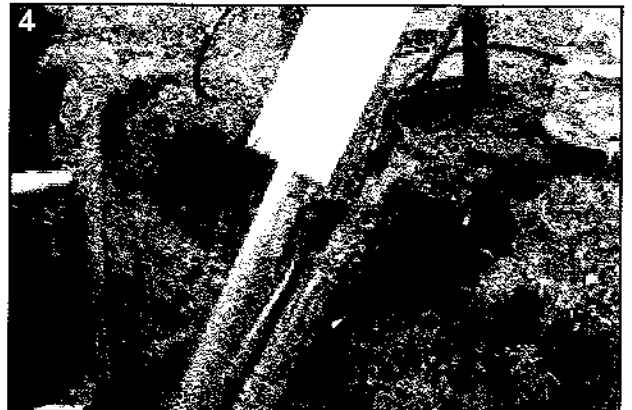

4 The shore will fold as it is pulled out. Remove tools, fold shore flat, and carry to the next installation spot.

TYPE A & B SOILS					
Depth of Trench (ft.)	Model Length (ft.) <i>WS= Standard WH= Heavy Duty</i>	Horiz. Cyl. Spacing (ft.)	Max. Vert. Spacing (ft.)	Max. Width of Trench (ft.) <i>Up to 12 ft. - SEE NOTE* 2 12-15 ft. - SEE NOTE* 9</i>	Sheeting <i>SEE NOTE* 3 and:</i>
UP TO 10'	6WS, 6WH	5	4'	12' to 15'	4
	8WS, 8WH	6.0, 7.0	4'	12' to 15'	4
	12WS3	5	4'	12' to 15'	4
	12WH3	5.25	4'	12' to 15'	4
	12WH	8	4'	12' to 15'	4
	12WHX	10.5	4'	12' to 15'	4
	16WH3	7.25	4'	12' to 15'	4
11' TO 15'	6WS, 6WH	5	4'	12' to 15'	5
	8WS, 8WH	6.0, 7.0	4'	12' to 15'	5
	12WS3	5	4'	12' to 15'	5
	12WH3	5.25	4'	12' to 15'	5
	12WH	8	4'	12' to 15'	5
	12WHX	10.5	4'	12' to 15'	5
	16WH4	7.25 (1)	4'	12' to 15'	5
16' TO 20'	6WS, 6WH	5	4'	12' to 15'	5
	8WH	7	4'	12' to 15'	5
	12WS3	5	4'	12' to 15'	5
	12WH3	5.25	4'	12' to 15'	5
	12WH	8	4'	12' to 15'	5
	16WH4	7.25 (1)	4'	12' to 15'	5

* SEE PAGE 14 FOR NOTES

Nomenclature for Water Models:

Prefix = water length

S = Standard Duty Walers

H = Heavy Duty Walers

X = 2 Cylinders At Maximum Spacing

Suffix = Number Of Cylinders

No Suffix = 2 Cylinders Minimum

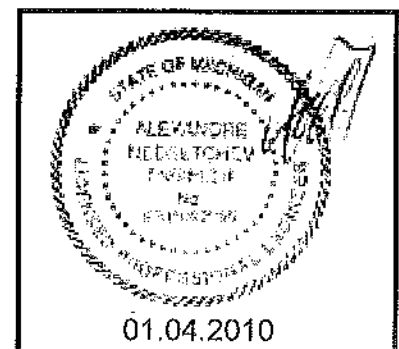

Hydraulic Aluminum Shoring - Tabulated Data

TYPE C-60 SOILS					
Depth of Trench (ft.)	Model Length (ft.) <i>WS= Standard WH= Heavy Duty</i>	Horiz. Cyl. Spacing (ft.)	Max. Vert. Spacing (ft.)	Max. Width of Trench (ft.) <i>Up to 12 ft. - SEE NOTE* 2 12-15 ft. - SEE NOTE* 9</i>	Sheeting <i>SEE NOTE* 3 and:</i>
UP TO 10'	6WS, 6WH	5	4'	12' to 15'	5
	8WS, 8WH	6.0, 7.0	4'	12' to 15'	5
	12WS3	5	4'	12' to 15'	5
	12WH3	5.25	4'	12' to 15'	5
	12WH	8	4'	12' to 15'	5
	12WHX	10.5	4'	12' to 15'	5
	16WH3	7.25	4'	12' to 15'	5
11' TO 15'	6WS, 6WH	5	4'	12' to 15'	6
	8WS, 8WH	6.0, 7.0	4'	12' to 15'	6
	12WS3	5	4'	12' to 15'	6
	12WH3	5.25	4'	12' to 15'	6
	12WH	8	4'	12' to 15'	6
	12WHX	10.5	4'	12' to 15'	6
	16WH4	7.25 (1)	4'	12' to 15'	6
16' TO 20'	6WS, 6WH	5	4'	12' to 15'	7
	8WH	7	4'	12' to 15'	7
	16WH4	7.25 (1)	4'	12' to 15'	7

* SEE PAGE 14 FOR NOTES

Nomenclature for Water Models:

Prefix = water length

S = Standard Duty Walers

H = Heavy Duty Walers

X = 2 Cylinders At Maximum Spacing

Suffix = Number Of Cylinders

No Suffix = 2 Cylinders Minimum

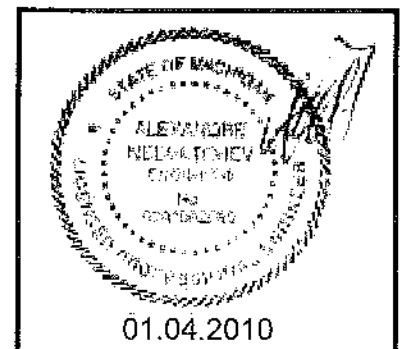

TYPE C-80 SOILS					
Depth of Trench (ft.)	Model Length (ft.) <i>WS= Standard WH= Heavy Duty</i>	Horiz. Cyl. Spacing (ft.)	Max. Vert. Spacing (ft.)	Max. Width of Trench (ft.) <i>Up to 12 ft. - SEE NOTE 2 12-15 ft. - SEE NOTE 9</i>	Sheeting <i>SEE NOTE 3 and:</i>
UP TO 10'	6WS, 6WH	5	4'	12' or 15'	7, 8
	8WH	7.0	4'	12' or 15'	7, 8
	12WH3	5.25	4'	12' or 15'	7, 8
	12WH	8	4'	12' or 15'	7, 8
	12WHX	10.5	4'	12' or 15'	7, 8
	16WH3	7.25	4'	12' or 15'	7, 8
11' TO 15'	6WH	5	4'	12' or 15'	7, 8
	8WH	6.0, 7.0	4'	12' or 15'	7, 8
	16WH4	7.25 (1)	4'	12' or 15'	7, 8
16' TO 20'	6WH	5	4'	12' or 15'	7, 8

NOTES:

- Utilize two, 2 in. diameter Hydraulic Cylinders. Trenches wider than 9'-4" up to 15' (112"-180") require Steel Oversleeves or universal one-piece aluminum extension, extending the full, collapsed length.
- Utilize two, 2 in. diameter Hydraulic Cylinders with standard or heavy duty extension system as required for desired excavation width.
- Plywood sheeting shall consist of 1.125 in. CDX plywood or .75 in. 14-ply Arctic Birch. Timber sheeting shall be #1 Douglas Fir with minimum Fb = 1,500 psi or equal.*
- Provide 4 ft. wide plywood or 2x8 ft. timber sheeting at 2'0" O.C. if raveling or sloughing of excavation face appears likely to occur. The bottom of the sheeting shall extend to within 2 ft. of the bottom of the excavation.
- Provide 4'0" wide plywood or 2x8 ft. timber sheeting at close spacing.
- Provide 2x8 ft. timber sheeting at close spacing to bottom of excavation.
- Provide 3x8 ft. timber sheeting at close spacing to bottom of excavation.
- The max-distance from the bottom of the excavation to the bottom water shall be 2½ ft. unless the sheeting is over-driven 1 ft. If over-driven, the maximum distance to the bottom water shall be 4 ft.
- Extra Heavy Duty Steel-Oversleeve Extensions Required
* See [13] of "General Information" for alternate sheeting.

Nomenclature for Waler Models:

Prefix = waler length

S = Standard Duty Walers

H = Heavy Duty Walers

X = 2 Cylinders At Maximum Spacing

Suffix = Number Of Cylinders

No Suffix = 2 Cylinders Minimum

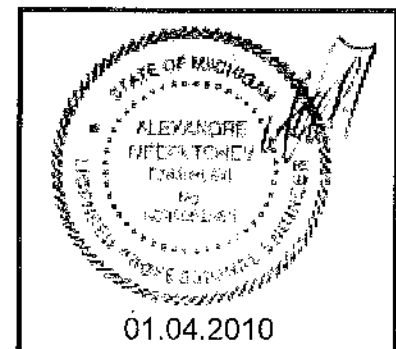

Hydraulic Aluminum Shoring - Tabulated Data

Water Rail Specification Sheet

Section Properties

	Standard Rail	Heavy Duty Rail
Material	Aluminum	Aluminum
Alloy	6061-T6	6061-T6
Area	4.87 in ²	9.76 in. ²
Weight	5.84 plf	11.72 plf
Section Modulus - Top (leg side)	S _x =3.62 in. ³	S _x =14.50 in. ³
Section Modulus - Bottom (blade side)	S _x =4.52 in. ³	S _x =14.40 in. ³
Equivalent Timber Size * (#2 Douglas Fir)	8x10 (on edge)	12x16 (on edge)

Standard Vertical Rail

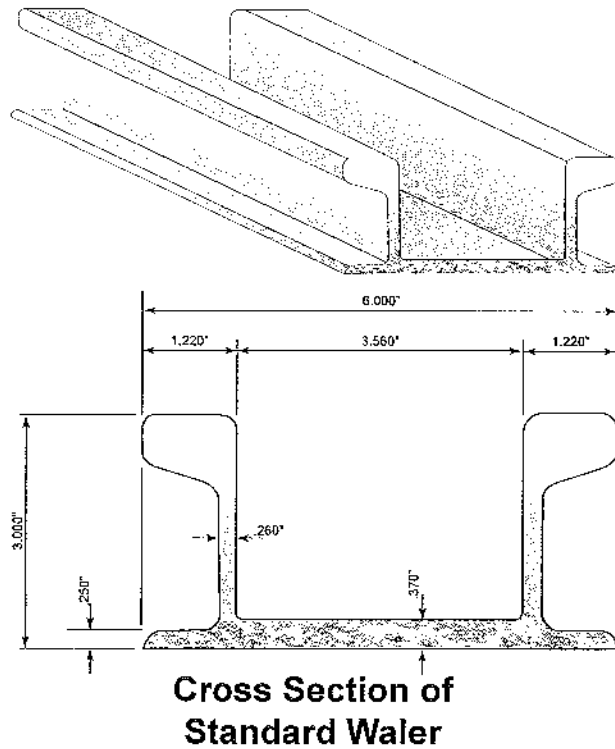

Heavy-Duty Vertical Rail

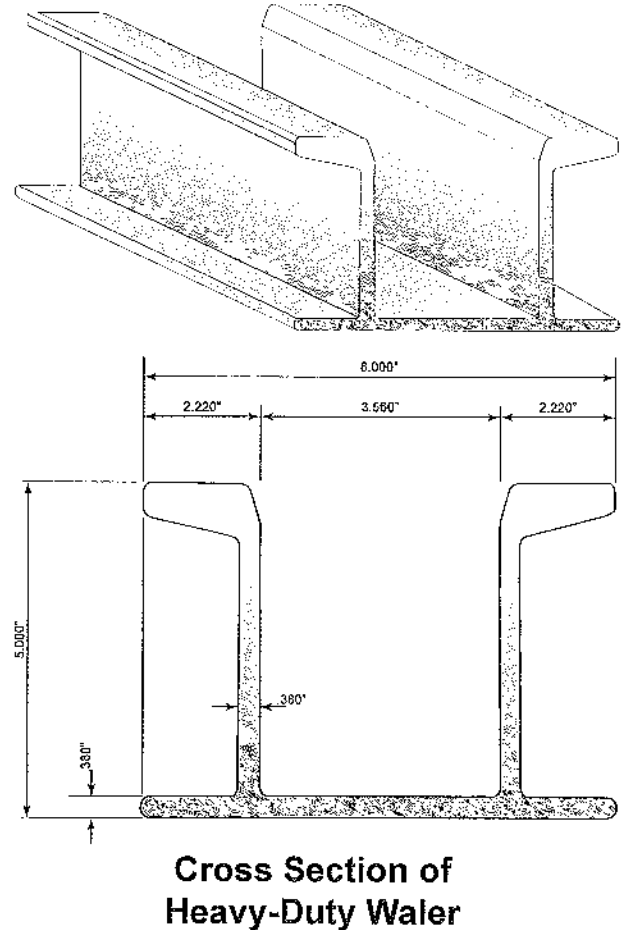

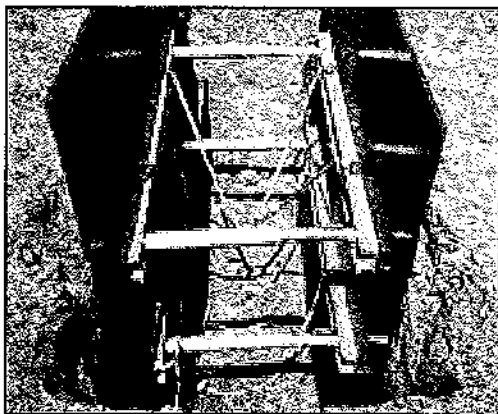
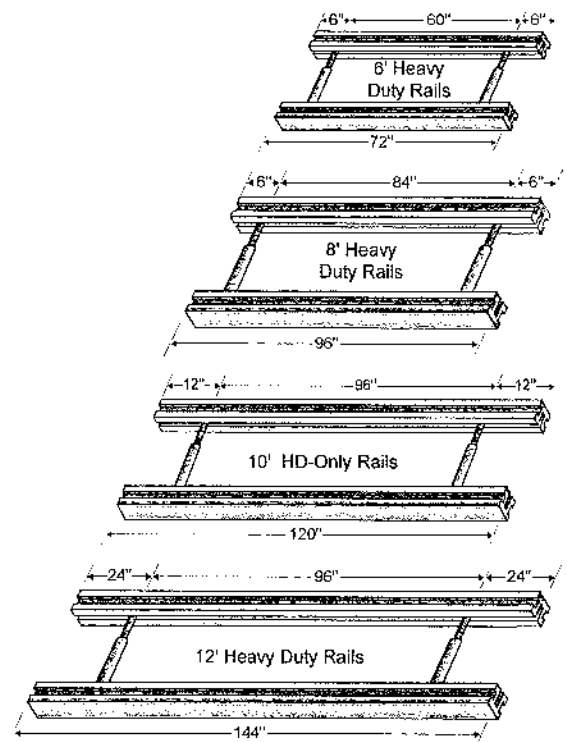
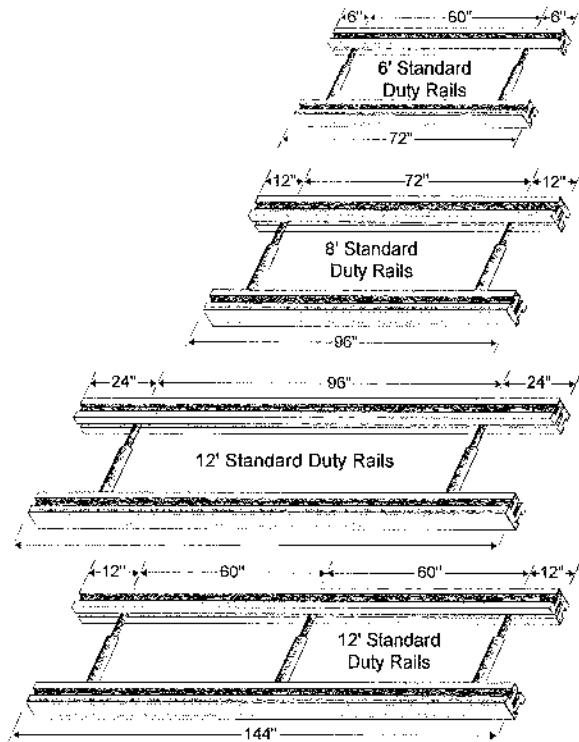

For installing walers into trench:

1. Attach sling to the lower waler set.
2. Lower the waler set stacked one on top of the other.
3. Lower the walers into the trench until the top set of walers are in place.
4. Pump the top cylinders out until the pump gage is in the green zone. Check pump gage to make sure pressure is holding.
5. Lower the bottom walers into place and repeat step 4.

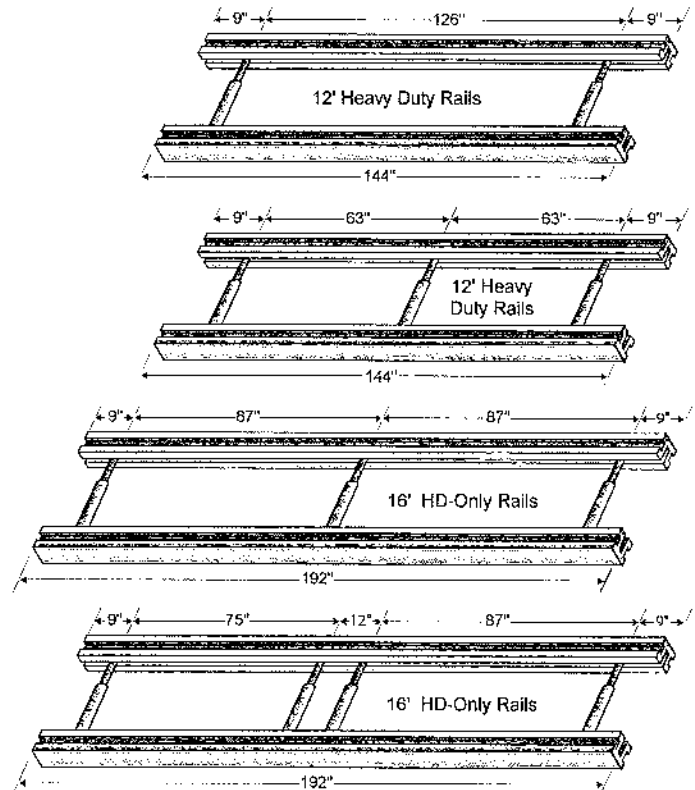

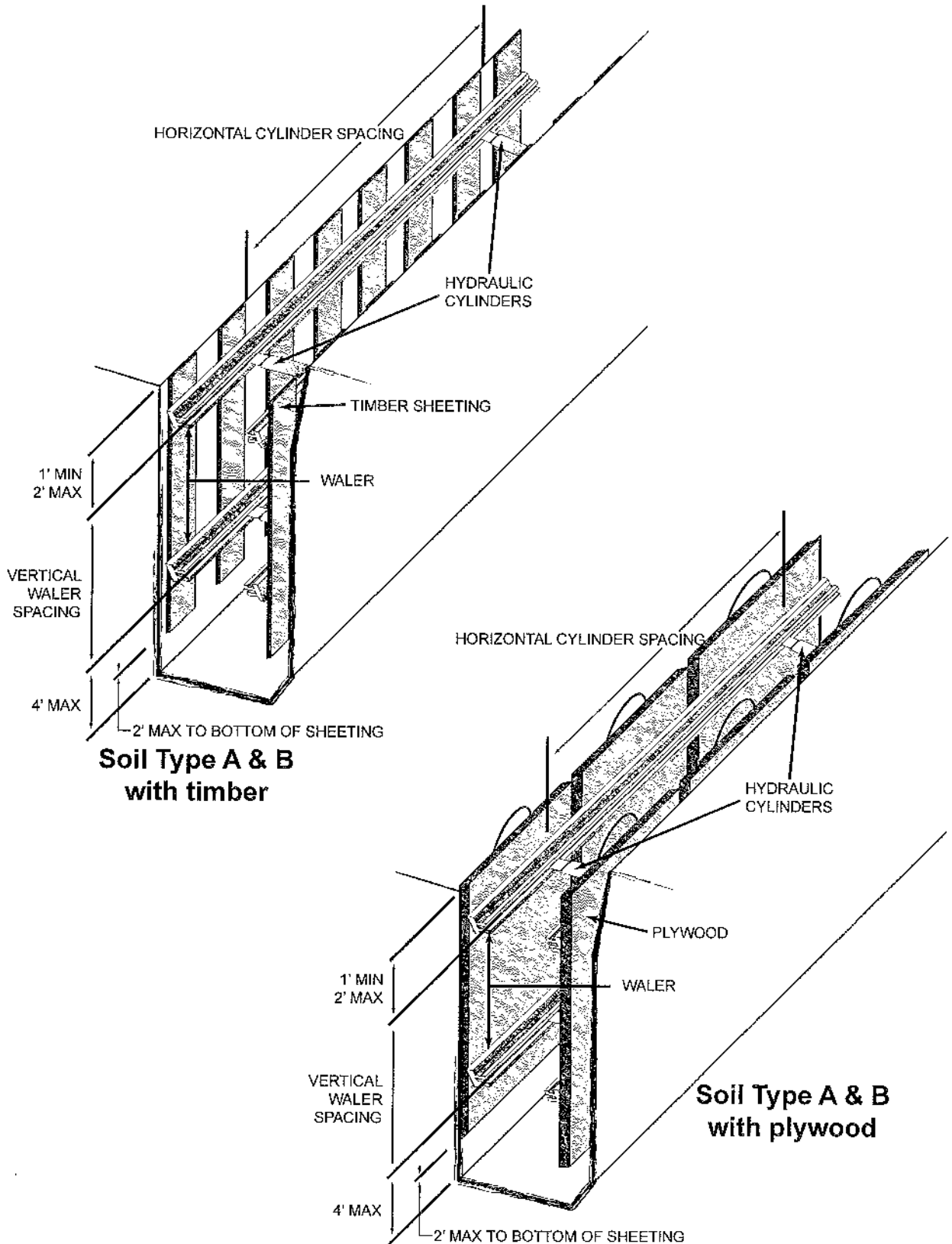

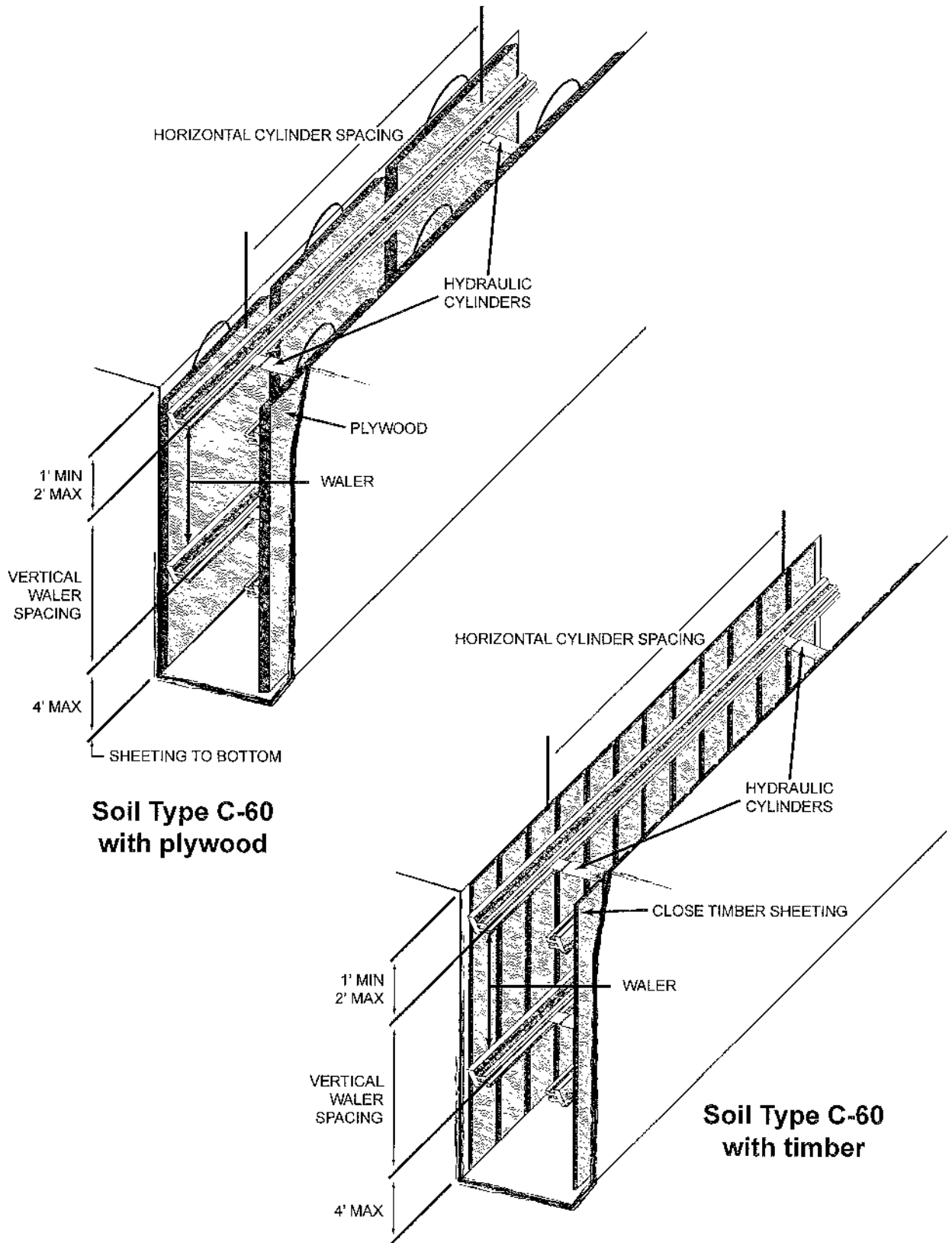

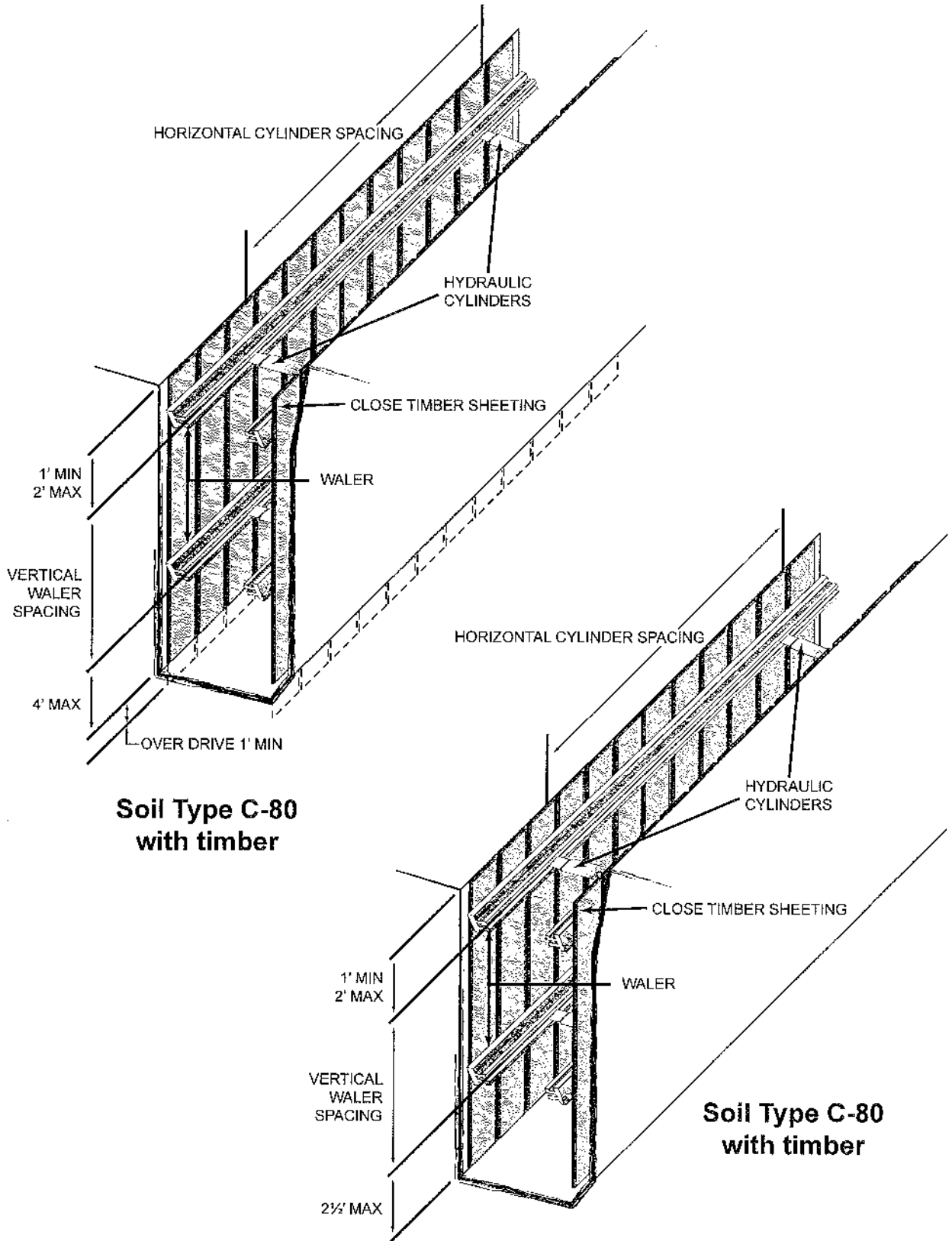

RAIL	WALER
LENGTH	8'
SECTION MODULUS	$S_x=14.5 \text{ in}^3$
SECTION PROFILE HEIGHT	5"
MAXIMUM CYLINDER LOADING	18,000 lbs.
CYLINDER NORMAL OPERATING PRESET PRESSURE	750—1500 PSI

ALLOWABLE HORIZONTAL SHORE SPACING (FT)			
DEPTH	TYPE A	TYPE B	TYPE C-60
5' - 8'	8'	7'	4'
10'	8'	6'	4'
12'	8'	5'	3'
14'	7'	4'	3'
16'	6'	4'	3'
18'	6'	3'	PLYWOOD OPTIONAL TO 8 FT. DEEP OR AS REQUIRED (SEE NOTE 3)
20'	4'	3'	
PLYWOOD OPTIONAL TO 8 FT. DEEP OR AS REQUIRED (SEE NOTE 3)			MUST USE PLYWOOD AFTER 8 FT.
USE PLYWOOD FOR RAVELING AND SLOUGHING			

Notes

A. Plywood is to be 1 1/8 in. cdx or 3/4 in. thick 14 ply fin form. Plywood is for raveling and sloughing only. It may be required in any type of soil and must be used in type 0—60 and greater soil over 8 ft. deep. (See page 1 for alternate plywood sheeting.)

B. There must be at least 3 columns of shoring in the trench at all times. At the horizontal spacing indicated (or less), to form a shoring system. In trenches over 12 ft. deep and if possible a minimum of four shores should be used. For excavations that are too short to place three or four shores at the required spacing, two shores shall be placed at the required spacing. There shall be a shore within 2 ft. - 6 in. of each end of the excavation.

C. Spacing charts allow for surcharge loading from equipment weighing 20 lbs. or less. For larger equipment the surcharge loading should be increased as determined by a registered civil engineer.

D. No vertical loads are to be applied to the shores.

E. Shore loading shall be determined from the depth of the excavation and not from the location of the cylinders.

F. Trenches wider than 9'-4" up to 15' (112"-180") require Efficiency's Steel Oversleeves extensions.

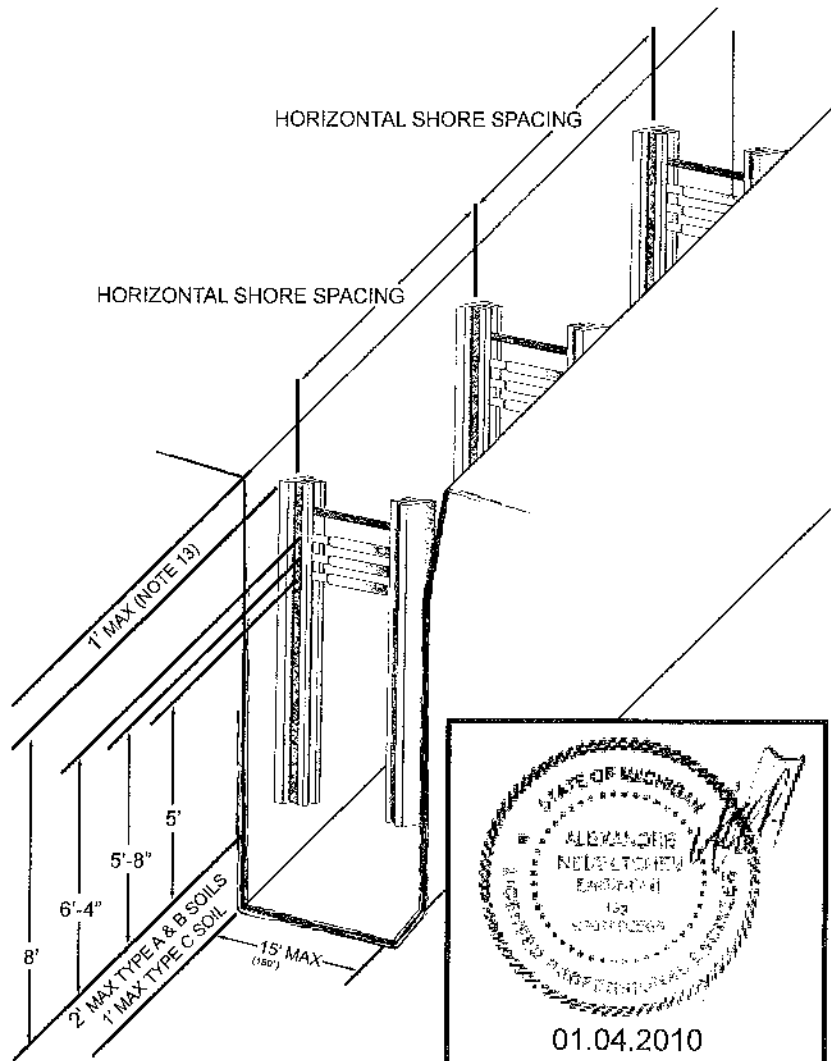

RAIL	WALER
LENGTH	10'
SECTION MODULUS	$S_x=14.5 \text{ in}^3$
SECTION PROFILE HEIGHT	5"
MAXIMUM CYLINDER LOADING	18,000 lbs.
CYLINDER NORMAL OPERATING PRESET PRESSURE	750—1500 PSI

ALLOWABLE HORIZONTAL SHORE SPACING (FT)			
DEPTH	TYPE A	TYPE B	TYPE C-60
9'	8'	7'	4'
10'	8'	7'	4'
12'	8'	6'	4'
14'	8'	5'	3'
16'	7'	4'	3'
18'	6'	3'	PLYWOOD OPTIONAL TO 8 FT. DEEP OR AS REQUIRED (SEE NOTE 3)
20'	4'	3'	
PLYWOOD OPTIONAL TO 8 FT. DEEP OR AS REQUIRED (SEE NOTE 3)			MUST USE PLYWOOD AFTER 8 FT.
USE PLYWOOD FOR RAVELING AND SLOUGHING			

Notes

A. Plywood is to be 1 1/8 in. cdx or 3/4 in. thick 14 ply fin form. Plywood is for raveling and sloughing only. It may be required in any type of soil and must be used in type 0—60 and greater soil over 8 ft. deep. (See page 1 for alternate plywood sheeting)

B. There must be at least 3 columns of shoring in the trench at all times. At the horizontal spacing indicated (or less), to form a shoring system. In trenches over 12 ft. deep and if possible a minimum of four shores should be used. For excavations that are too short to place three or four shores at the required spacing, two shores shall be placed at the required spacing. There shall be a shore within 2 ft. - 6 in. of each end of the excavation.

C. Spacing charts allow for surcharge loading from equipment weighing 20 lbs. or less. For larger equipment the surcharge loading should be increased as determined by a registered civil engineer.

D. No vertical loads are to be applied to the shores.

E. Shore loading shall be determined from the depth of the excavation and not from the location of the cylinders.

F. Trenches wider than 9'-4" up to 15' (112"-180") require Efficiency's Steel Oversleeves extensions.

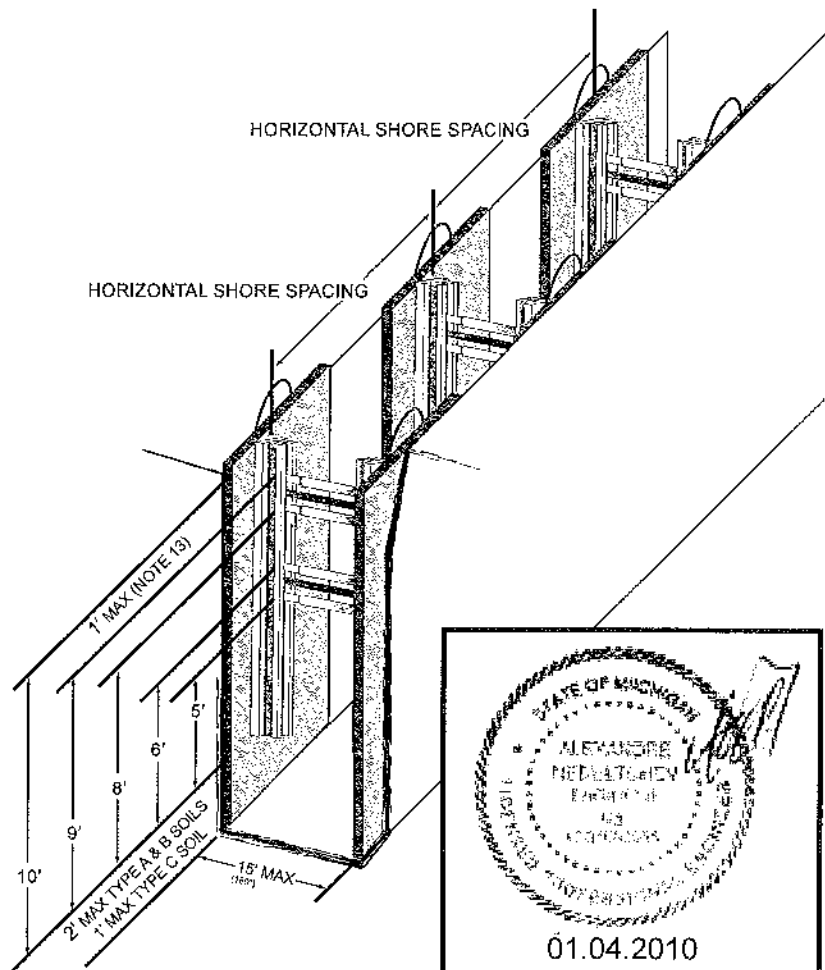

RAIL	WALER
LENGTH	12'
SECTION MODULUS	$S_x=14.5 \text{ in}^3$
SECTION PROFILE HEIGHT	5"
MAXIMUM CYLINDER LOADING	18,000 lbs.
CYLINDER NORMAL OPERATING PRESET PRESSURE	750—1500 PSI

ALLOWABLE HORIZONTAL SHORE SPACING (FT)			
DEPTH	TYPE A	TYPE B	TYPE C-60
11'	8'	7'	4'
12'	8'	6'	4'
14'	8'	5'	3'
16'	7'	4'	3'
18'	6'	3'	PLYWOOD OPTIONAL TO 8 FT. DEEP OR AS REQUIRED (SEE NOTE 3)
20'	4'	3'	
PLYWOOD OPTIONAL TO 8 FT. DEEP OR AS REQUIRED (SEE NOTE 3)			MUST USE PLYWOOD AFTER 8 FT.
USE PLYWOOD FOR RAVELING AND SLOUGHING			

Notes

A. Plywood is to be 1 1/2 in. cdx or 3/4 in. thick 14 ply fir form. Plywood is for raveling and sloughing only. It may be required in any type of soil and must be used in type 0-60 and greater soil over 8 ft. deep. (See page 1 for alternate plywood sheeting)

B. There must be at least 3 columns of shoring in the trench at all times. At the horizontal spacing indicated (or less), to form a shoring system. In trenches over 12 ft. deep and if possible a minimum of four shores should be used. For excavations that are too short to place three or four shores at the required spacing, two shores shall be placed at the required spacing. There shall be a shore within 2 ft. - 6 in. of each end of the excavation.

C. Spacing charts allow for surcharge loading from equipment weighing 20 lbs. or less. For larger equipment the surcharge loading should be increased as determined by a registered civil engineer.

D. No vertical loads are to be applied to the shores.

E. Shore loading shall be determined from the depth of the excavation and not from the location of the cylinders.

F. Trenches wider than 9'-4" up to 15' (112"-180") require Efficiency's Steel Oversleeves extensions.

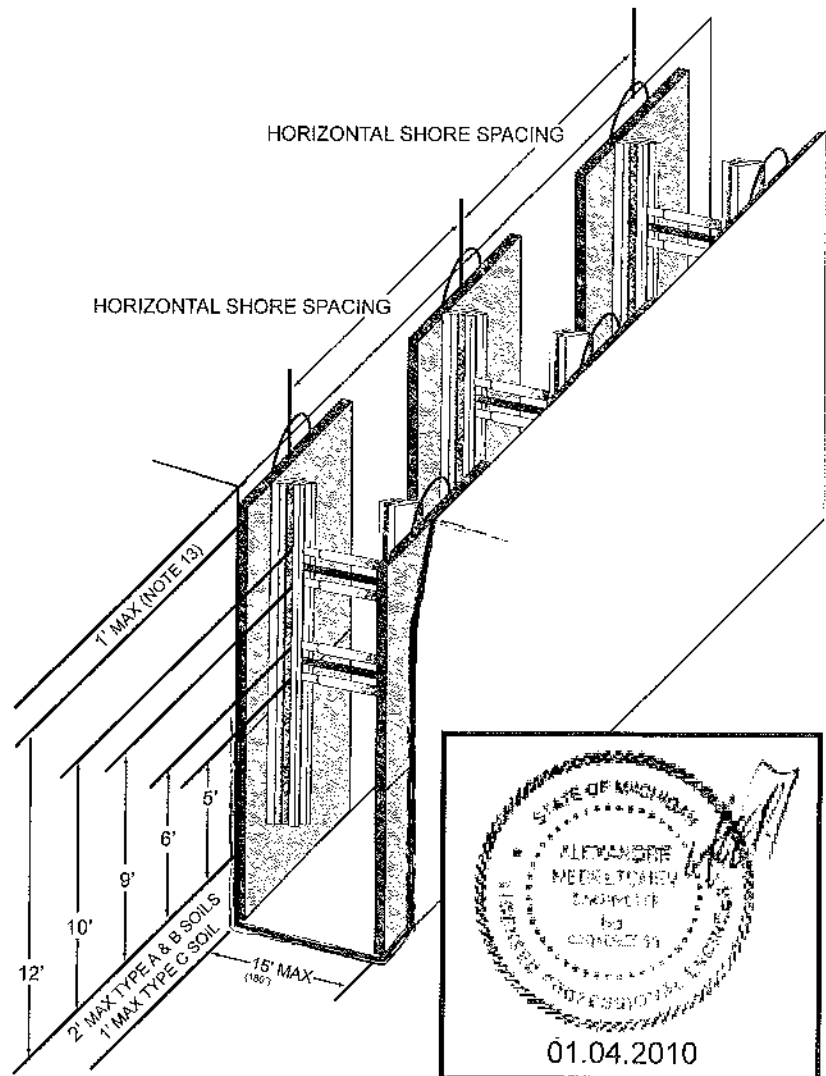

RAIL	WALER
LENGTH	16'
SECTION MODULUS	$S_x=14.5 \text{ in}^3$
SECTION PROFILE HEIGHT	5"
MAXIMUM CYLINDER LOADING	18,000 lbs.
CYLINDER NORMAL OPERATING PRESET PRESSURE	750—1500 PSI

ALLOWABLE HORIZONTAL SHORE SPACING (FT)			
DEPTH	TYPE A	TYPE B	TYPE C-60
14'	7'	4'	3'
16'	6'	4'	3'
18'	6'	3'	PLYWOOD OPTIONAL TO 8 FT. DEEP OR AS REQUIRED (SEE NOTE 3)
20'	4'	3'	
PLYWOOD OPTIONAL TO 8 FT. DEEP OR AS REQUIRED (SEE NOTE 3)			MUST USE PLYWOOD AFTER 8 FT.
USE PLYWOOD FOR RAVELING AND SLOUGHING			

Notes

A. Plywood is to be 1 1/4 in. cdx or 3/4 in. thick 14 ply fin form. Plywood is for raveling and sloughing only. It may be required in any type of soil and must be used in type 0—60 and greater soil over 8 ft. deep. (See page 1 for alternate plywood sheeting)

B. There must be at least 3 columns of shoring in the trench at all times. At the horizontal spacing indicated (or less), to form a shoring system. In trenches over 12 ft. deep and if possible a minimum of four shores should be used. For excavations that are too short to place three or four shores at the required spacing, two shores shall be placed at the required spacing. There shall be a shore within 2 ft. - 6 in. of each end of the excavation.

C. Spacing charts allow for surcharge loading from equipment weighing 20 lbs. or less. For larger equipment the surcharge loading should be increased as determined by a registered civil engineer.

D. No vertical loads are to be applied to the shores.

E. Shore loading shall be determined from the depth of the excavation and not from the location of the cylinders.

F. Trenches wider than 9'-4" up to 15' (112"-180") require Efficiency's Steel Oversleeves extensions.

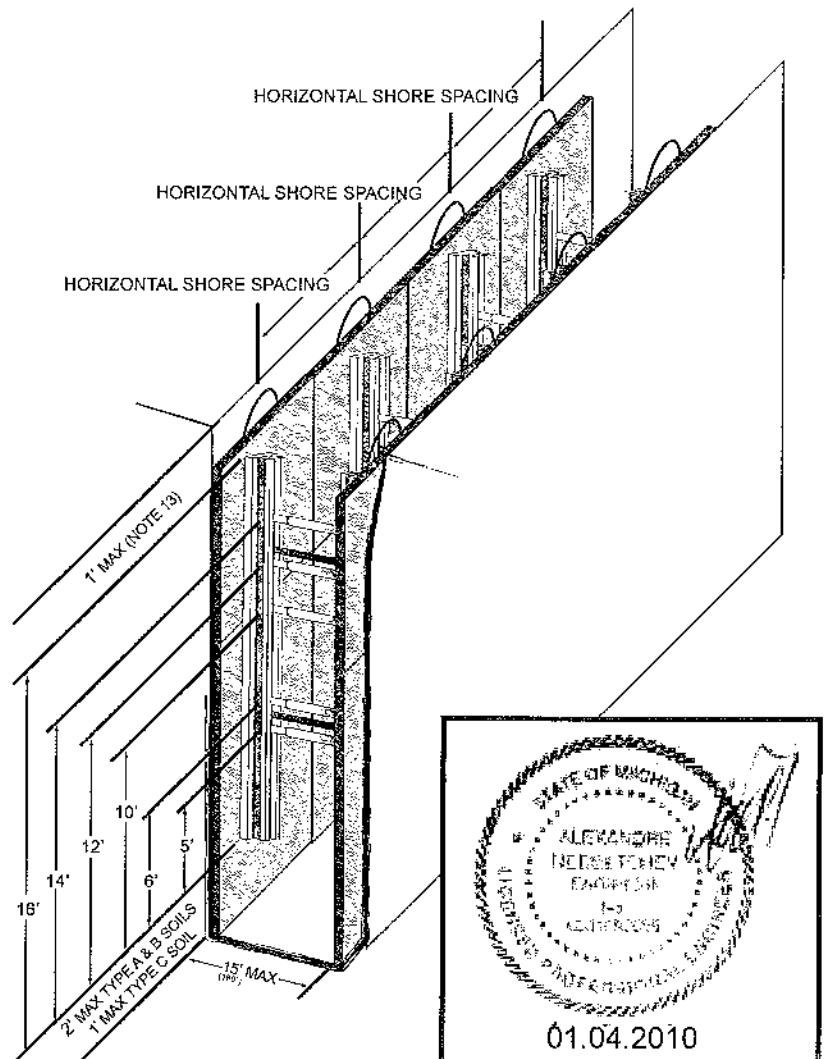

Basis and Limitations of the Data for End Shores

- A. When End Shores are used with Vertical Shores, the horizontal spacing between the End Shore and the first Vertical Shore shall not exceed the spacing shown in the Tabulated Data tables for Vertical Shores for the soil type and depths encountered in the trench. If sheeting is necessary behind the Vertical Shores, the End Shore shall be placed close to the end Vertical Shore sheeting.
- B. When End Shores are used with Waler Systems there shall be no more than 4 feet clear between the end of the End Shore and the end of the first Wale.
- C. When End Shores are used with Hydraulic Aluminum Shields there shall be no more than 2 feet clear between the end of the End Shore and the end of the Shoring Shield.
- D. When End Shores are used with Trench Shields there shall be no more than 4 feet clear between the end of the End Shore and the Trench Shield.
- E. The End Shores may be used only in the Hydraulic modes with the hydraulic cylinders pressurized.
- F. The maximum operating width of End Shores is 12 feet.
- G. The bottom Hydraulic Quickbrace shall be located no more than 4 feet above the bottom of the excavation. The top hydraulic Quickbrace shall be located between one foot and two feet below the top of the excavation.
- H. The sheeting directly behind the end of each Hydraulic Quickbrace must bear on firm soil or solid and stable filler to distribute the cylinder load to the face of the excavation.
- I. The top of the sheeting shall be level with the top of the excavation or above it.
- J. The faces of the excavation must be cut near vertical and straight.

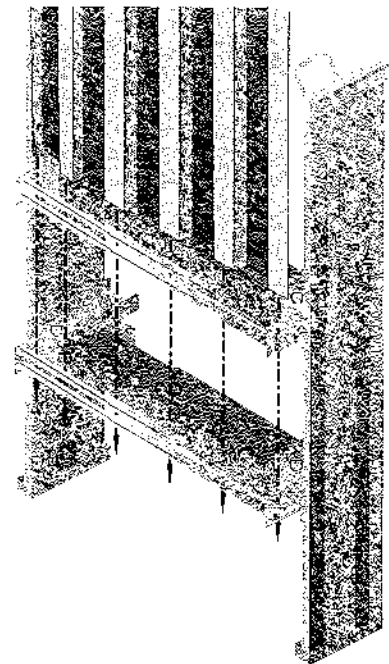
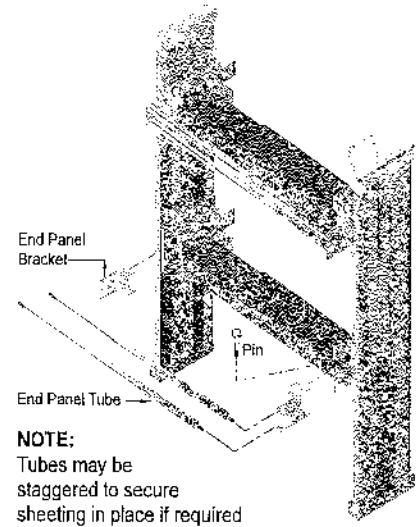

NEXT PAGE

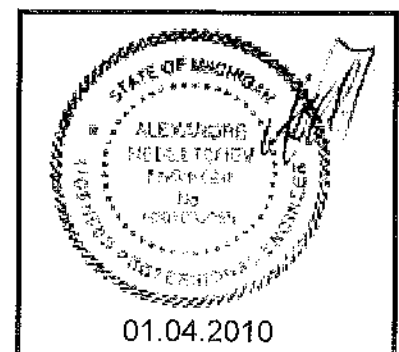

Revised: February 8, 2013 - CHANGE ONE

The following additional certifications apply to pages 1-25 of this document, stamped by Alex Nedeltchev, P.E., on January 4, 2010.

 <p>LICENSED PROFESSIONAL ENGINEER A.V. NEDELTCHEV PROVINCE OF ONTARIO</p>	 <p>PROFESSIONAL ENGINEER ALBERTA ALEX NEDELTCHEV 01.04.2010</p>	 <p>PROFESSIONAL ENGINEER A.V. NEDELTCHEV Member 33107 01.04.2010</p>
 <p>PROFESSIONAL ENGINEER A.V. NEDELTCHEV MEMBER 14102 01.04.2010 SASKATCHEWAN</p>	 <p>PROFESSIONAL ENGINEER DATE 01.04.2010 A.V. Nedeltchev 9001 PROVINCE OF NOVA SCOTIA</p>	 <p>PROFESSIONAL ENGINEER PROVINCE OF A. NEDELTCHEV # 31003 01.04.2010 MANITOBA</p>
 <p>PROFESSIONAL ENGINEER 2010 Alexandre V. Nedeltchev 01.04.2010</p>	 <p>ORDRE DES INGÉNIEURS DU QUÉBEC Permis Temporaire / Temporary Licence Nom / Name: Alexandre Nedeltchev No. DID: PTO 1008 Valable après / Valid after: 2010-08-13 Site: DEALERSHIPS HEWITT CAT / POINTE-CLAIRE</p>	

The following additional certifications apply to pages 1-25 of this document.

