

# MANHOLE BOX CERTIFICATION

A COPY OF THIS SHEET MUST ACCOMPANY EACH CORRESPONDING  
MANHOLE BOX AT EVERY JOB SITE



MODEL NUMBER	HEIGHT	SERIAL NUMBER	SIZE
TAP3-488DNKE	4'	30674	8'x8'x4'

SOIL	MAX DEPTH	PSF	SOIL DESCRIPTION
TYPE A	40	1680	Stiff Cohesive Soil, 25 PSF per foot, clay, silty clay, clay loam with unconfined compressive strength of 1.5 ton per square foot or greater. See note 7.
TYPE B	39	1680	Medium Cohesive to granular soil, 45 PSF per foot of depth. Clay with unconfined compressive strength greater than 0.5 TSF but less than 1.5 TSF. Cohesionless gravel, silt, silt loam or sandy loam. See note 8.
TYPE C	30	1680	Soft Cohesive to Saturated Soil, 60 PSF per foot of depth. Clay with unconfined compressive strength less than 0.5 TSF, saturated sand, clay or fractured rock that is not stable. See note 9.

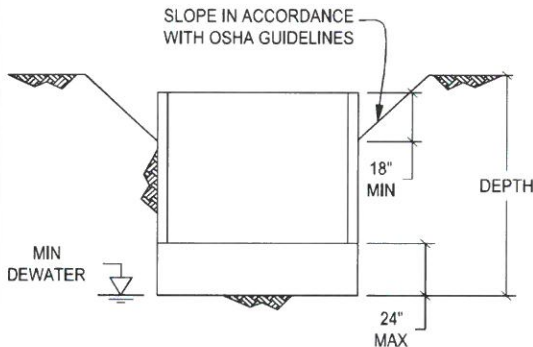

## LIMITATIONS

- 1) This tabulated data has been prepared by a registered professional engineer as required to comply with OSHA standard 29 CFR part 1926, subpart P.
- 2) Box may be suspended no more than 2 feet above bottom of the trench and only if there is no possible loss of soil from behind or below bottom of shield.
- 3) Shoring box shall be installed in a manner that will prevent lateral or otherwise hazardous movement of soils. Shoring box is not intended to provide stability to adjacent buildings or other structures.
- 4) Soil above shield must be sloped according to OSHA Subpart P. Slope must begin no less than 18" below the top of box. Excavations over 20'-deep with slopes require site specific approval.
- 5) Boxes may be stacked as long as each is rated to the depth it is used and manufacturer approved stack connections are utilized to prevent lateral movement of the shields.
- 6) Surcharge loads have not been included in the above depth ratings. The allowable working depth of the box must be reduced to account for any surcharge loading which occurs within the influence line of the shield. Otherwise, site specific engineering is required.
- 7) Not Type A if fissured. Subject to vibration, previously disturbed or part of a sloped layered system where layers dip into excavation on a slope less steep than four horizontal to one vertical (4H:1V) are Type B if material would otherwise be classified as Type B.
- 8) Previously disturbed soils may be Type B unless they would be classed as Type C. Soil that meets requirements of Type A but is subject to vibration or fissured may be Type B. Dry rock that is not stable or soil that is part of a sloped layered system where layers dip into the excavation on a slope less steep than four horizontal to one vertical (4H:1V) are Type B if material would otherwise be classified as type B.
- 9) Soil in a sloped layered system where layers dip into the excavation on a slope of four horizontal to one vertical (4H:1V) or steeper may be Type C. Saturated soil or soils from which water is freely seeping but is not standing in the trench. Conditions more severe would require dewatering or the sealing of the sides of the excavation and pumping the trench. Such severe conditions would require the services of a soils engineer to establish the design pressure. Consult the manufacturer for pressures exceeding tabulated values.
- 10) Any modifications to boxes will void tabulated data unless otherwise specified or allowed in writing by Pro-Tec Equipment.
- 11) Boxes must be inspected prior to each use for any damage or deterioration. If any box has sustained damage or permanent deformation, the tabulated data is void until repairs are made as specified by a registered professional engineer.
- 12) PRO-TEC boxes are to be used in accordance with Federal, state and local laws. Refer to Occupational Safety and Health Administration (OSHA) rules and regulations Vol. 54, No. 209, 10/31/89. Subpart P.
- 13) Contractor is fully responsible for ensuring groundwater level on all sides of shoring is maintained below base of excavation at all times, otherwise certification is invalid.



AUG 18 2015



**TRINITY SHORING PRODUCTS, INC.**  
A TRINITY MINING & CONSTRUCTION EQUIPMENT, INC. COMPANY

Capacity and depth ratings account for 33%  
overstress for short-term loading condition

Tab data is only valid for TAP box model and serial number shown above with framing shown on Pro-Tec fabrication drawings dated 6/15/2005 for TAP box model number TB-3 488DNKE-8ISP/SPECIAL.

**Usage of boxes other than specified could cause failure or cave-ins resulting in serious injury or death.**

Phone (517) 541-0303 ~ 1-800-292-1225 ~ Fax (517) 541-0329

Address: 4837 West Grand River Ave. ~ Lansing, MI 48906