

# TRENCH SHIELD CERTIFICATION

A COPY OF THIS SHEET MUST ACCOMPANY EACH CORRESPONDING TRENCH SHIELD AT EVERY JOB SITE



| MODEL NUMBER | WEIGHT | SERIAL NUMBER | SIZE      |
|--------------|--------|---------------|-----------|
| PRO4-1016 D  | 9,905  | 28132         | 10' x 16' |

| SOIL   | MAX DEPTH (FT) | CAPACITY (PSF) |
|--------|----------------|----------------|
| TYPE A | 40             | 1020           |
| TYPE B | 28             | 1020           |
| TYPE C | 22             | 1020           |

## LIMITATIONS

- 1.) This tabulated data has been prepared by a registered professional engineer as required to comply with OSHA standard 29 CFR part 1926, subpart P.
- 2.) Surcharge loads have not been included in the above depth ratings. The allowable working depth of the shield must be reduced to account for any surcharge loading which occurs within the influence line of the shield. Otherwise, site specific engineering is required.
- 3.) Shield may be suspended no more than 2 feet above bottom of the trench and only if there is no possible loss of soil from behind or below bottom of shield.
- 4.) The sides of the excavation shall be cut vertical and narrow to prevent lateral movement, backfill voids between excavation and face of shoring shield.
- 5.) Shield to be used with 8" diameter schedule 80 pipe spreaders with a minimum yield strength of 50 ksi, and limited to a maximum length of 15'.
- 6.) Soil above shield must be sloped according to OSHA Subpart P, & must begin no less than 18" below top of panel. Excavations over 20'-deep with slopes require site specific approval.
- 7.) Shields may be stacked as long as each panel is rated to the depth it is used and manufacturer approved stack connections are utilized to prevent lateral movement of the shields.
- 8.) No steel plates, sheet piles, or sheathing of any kind may be leaned against, or otherwise supported by pipe spreaders at any time. Do not suspend load from pipe spreaders.
- 9.) Contractors' competent person is fully responsible for classifying soils in accordance with OSHA guidelines, prior to use of system.
- 10.) Any modifications to panels will void tabulated data unless otherwise specified or allowed in writing by Pro-Tec Equipment.
- 11.) Shields must be inspected prior to each use for any damage or deterioration. If any assembly has sustained damage or permanent deformation, the tabulated data is void until repairs are made as specified by a registered professional engineer.
- 12.) Pro-Tec shoring systems are to be used in accordance with Federal, state and local laws. Refer to Occupational Safety and Health Administration (OSHA) rules and regulations Vol. 54, No. 209, 10/31/89. Subpart P.
- 13.) Shoring must be clear of all adjacent building structures by a distance equal to four times the maximum cut depth at all times, otherwise certification is invalid and site specific engineering is required.
- 14.) Contractor is fully responsible for ensuring groundwater level on all sides of shoring is maintained below base of excavation at all times, otherwise certification is invalid.
- 15.) Certification based on shields fabricated in accordance with Pro-Tec drawing PRO4-1016DNOKE 4PR 22FT OSP/SPECIAL dated 7-03-2012

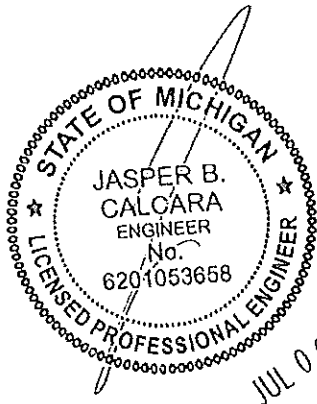
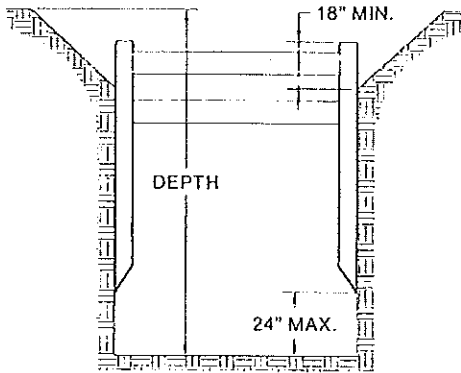

2" DIAM. PINS SHALL HAVE MIN  $F_u = 100$  KSI.  
CONTRACTOR RESPONSIBLE FOR ENSURING  
PROPER GRADE PINS ARE IN PLACE PRIOR  
TO SHIELD USE.

Capacity and depth ratings account for 33%  
overstress for short-term loading

Usage of shields other than specified could cause failure  
or cave-ins resulting in serious injury or death.

Phone (517) 541-0303 - 1-800-292-1225 - Fax (517) 541-0329  
Mailing Address: P.O. Box 130 - Charlotte, MI 48813  
Shipping Address: 1298 Lipsey Drive - Charlotte, MI 48813

**How to ASSEMBLE a trench shield:**

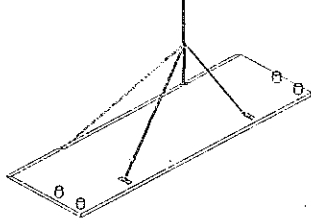

1. Remove from truck by lifting panels with 4 point lift lugs. Always use OSHA approved slings.

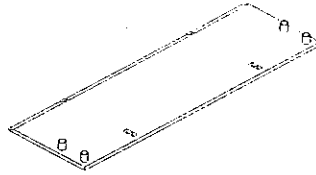

2. Place one sidewall flat on the ground with collars pointing up.

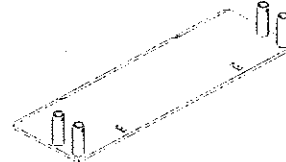

3. Set the spreader pipes over the collars and insert pins and keepers.

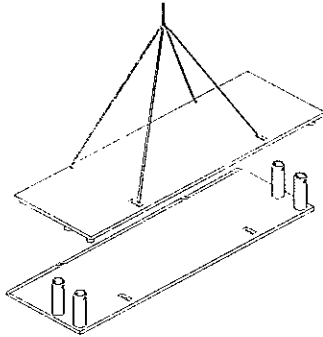

4. Set matching panel over bottom panel. Install Spreader pipes in collars and insert pins and keepers.

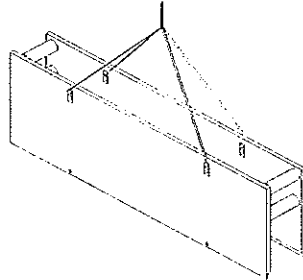

5. Place sling in top 4 lift lugs. Stand shield and install into trench.

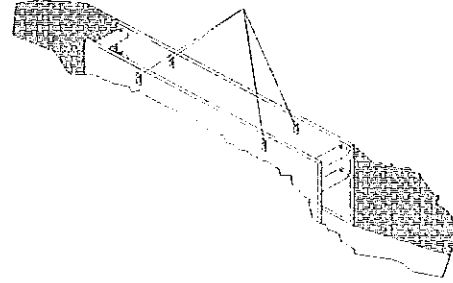

6. **WARNING:** Lift eyes are designed and intended for assembly and lifting only. Do not pull or lift by eyes when shield is stuck or has pressure against it. Loosen shield by pulling on spreader or digging along sides before using lift eyes.

**How to use a trench shield in STABLE soils:**

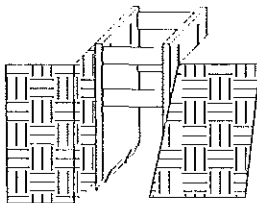

1. Excavate trench to grade, slightly wider than shield. Lift and lower shield into trench.

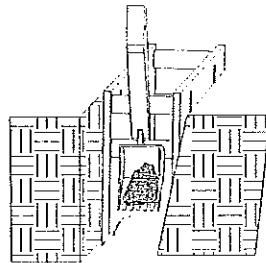

2. Perform desired work, then excavate in front of shield.

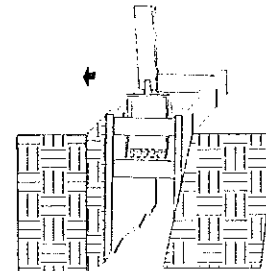

3. Pull shield forward by front spreaders or pulling eyes. Continue excavating and pull shield forward. Back fill as work progresses.

**How to use a trench shield in UNSTABLE soils:**

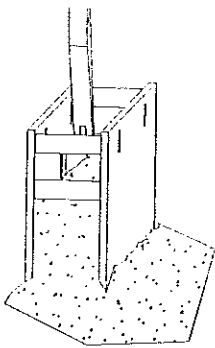

1. Excavate until soil begins to crumble beyond desired trench width. Place shield on line of excavation and excavate from within.

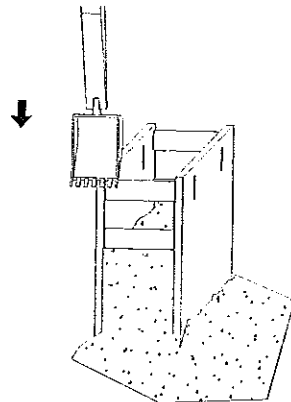

2. Continue excavating with in shield while alternately pushing down on shield corners, until proper grade is reached.

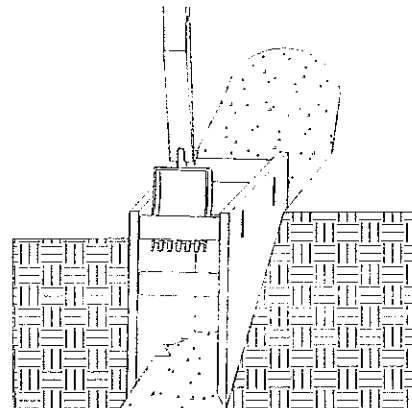

3. Perform desired work, then pull shield forward and up at appropriate angle and repeat steps (2) and (3) as necessary.