



## TRENCH SHIELD TABULATED DATA

A COPY OF THIS SHEET MUST ACCOMPANY EACH CORRESPONDING TRENCH SHIELD AT EVERY JOB SITE

MODEL NUMBER: PRO4-820D SPECIAL

SERIAL NUMBER: 27932

SOIL	MAX DEPTH	PSF
TYPE A	47 - FT	1320*
TYPE B	28 - FT	
TYPE C60	22 - FT	
TYPE C80	17 - FT	

DATE MANUFACTURED: 05/02/12  
 SHIELD WEIGHT: 10,200 - LB  
 SHIELD SIZE: 8 - FT X 20 - FT  
 SPREADER SIZE: 8 IN SCH 80  
 MAX SPREADER LENGTH: 15 - FT

\*Shield Capacity based on C60 soil at bottom of the excavation.

### LIMITATIONS:

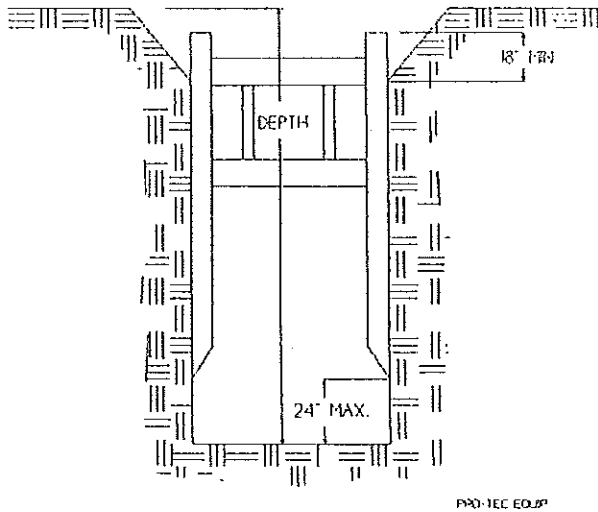

1. Soil above shield must be sloped according to OSHA Subpart P. Slope must begin no less than 18" below the top of shield.
2. Shield may be suspended no more than 2 feet above bottom of the trench and only if there is no possible loss of soil from behind or below bottom of shield.
3. A minimum of 2 spreader pipes are required on each end with manufacturer approved 1 3/4-in diameter pins and keepers.
4. Repairs and modifications shall be approved in writing by the manufacturer and a registered professional engineer.
5. Shields may be stacked as long as each is rated to the depth it is used and manufacturer approved stack connections are utilized.
6. Surcharge loads have not been included in the above depth ratings. The allowable working depth of the shield must be reduced to account for all surcharge loading which occurs adjacent to the trench. (Adjacent is defined as within a distance equal to the depth of the trench.)
7. The Soil Types A, B, and C - 80 are as defined in the OSHA Standard. Soil Type C - 60 is a moist, cohesive soil or a moist dense granular soil, which is not flowing or submerged and has an Equivalent Fluid Pressure (EFP) of 60 PSF per foot of depth. The competent person must monitor the excavation for signs of deterioration that may alter soil pressures and produce the Soil Type C - 80 condition. Such signs are indicated by, but not limited to, freely seeping water or flowing soil entering the excavation around or below the shield.
8. PRO-TEC trench shields have been designed by a registered professional engineer as required to comply with Occupational Safety and Health Administration (OSHA) standard 29 CFR Part 1926, Subpart P.
9. Maximum depths are based on shields being in structurally sound condition. Trench Shields should be inspected prior to each use for any damage or deterioration. If a shield has sustained major structural damage or permanent deformation of a structural member or connection, the Tabulated Data is void until repairs are made as specified by a registered professional engineer.

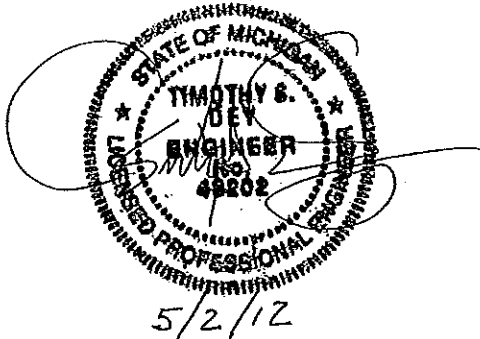

JN 5054

Usage of trench shields other than specified could cause failure or cave-ins resulting in serious injury or death.

Phone (517) 541-0303 • 1-800-292-1225 • Fax (517) 541-0329

Mailing Address: P.O. Box 130 • Charlotte, MI 48813 • Shipping Address: 1298 Lipsey Drive • Charlotte, MI 48813

**How to ASSEMBLE a trench shield:**

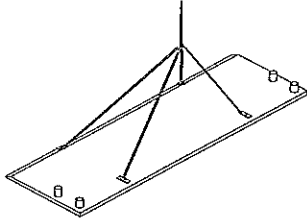

1. Remove from truck by lifting panels with 4 point lift lugs. Always use OSHA approved slings.

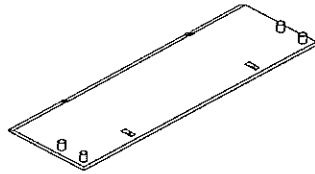

2. Place one sidewall flat on the ground with collars pointing up.

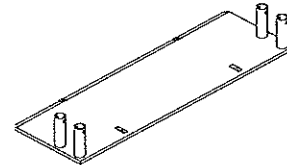

3. Set the spreader pipes over the collars and insert pins and keepers.

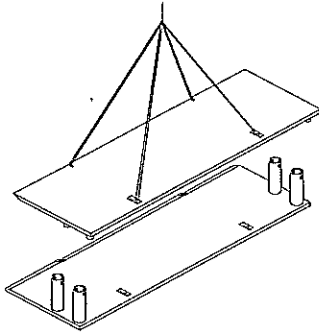

4. Set matching panel over bottom panel. Install Spreader pipes in collars and insert pins and keepers.

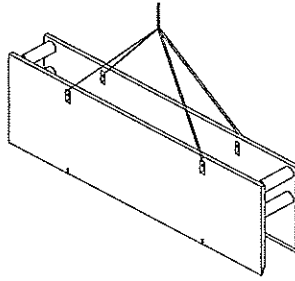

5. Place sling in top 4 lift lugs. Stand shield and install into trench.

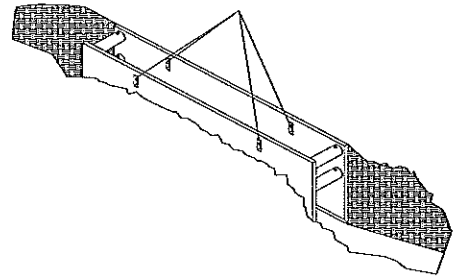

6. **WARNING:** Lift eyes are designed and intended for assembly and lifting only. Do not pull or lift by eyes when shield is stuck or has pressure against it. Loosen shield by pulling on spreader or digging along sides before using lift eyes.

**How to use a trench shield in STABLE soils:**

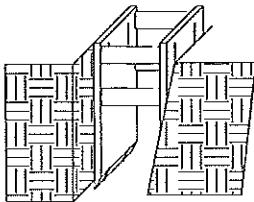

1. Excavate trench to grade, slightly wider than shield. Lift and lower shield into trench.

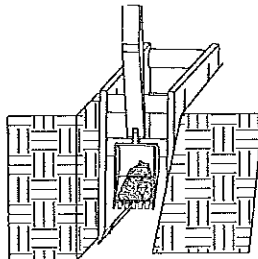

2. Perform desired work, then excavate in front of shield.

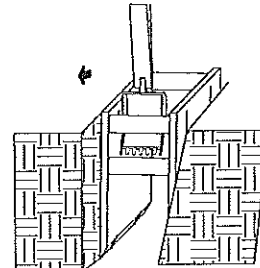

3. Pull shield forward by front spreaders or pulling eyes. Continue excavating and pull shield forward. Back fill as work progresses.

**How to use a trench shield in UNSTABLE soils:**

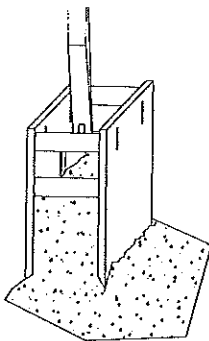

1. Excavate until soil begins to crumble beyond desired trench width. Place shield on line of excavation and excavate from within.

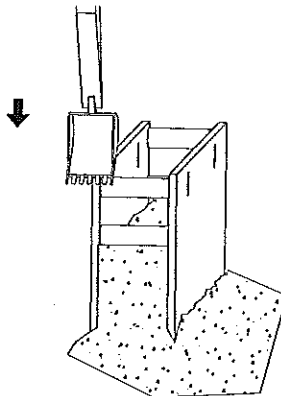

2. Continue excavating with in shield while alternately pushing down on shield corners, until proper grade is reached.

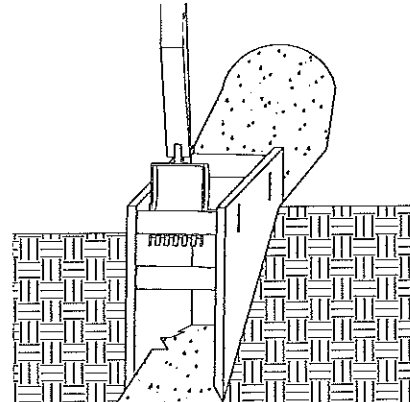

3. Perform desired work, then pull shield forward and up at appropriate angle and repeat steps (2) and (3) as necessary.