



TRENCH SHIELD CERTIFICATION

A COPY OF THIS SHEET MUST ACCOMPANY EACH
CORRESPONDING TRENCH SHIELD AT EVERY JOB SITE

MODEL NUMBER	WEIGHT	SERIAL NUMBER	SIZE
PRO6 - 1020D	12,571	20031	10' HIGH X 20' LONG

SOIL	MAX DEPTH	PSF	SOIL DESCRIPTION
TYPE A	48 FEET	1200	Stiff Cohesive Soil, 25 PSF per foot, clay, silty clay, clay loam with unconfined compressive strength of 1.5 ton per square foot or greater. See note 7.
TYPE B	27 FEET	1200	Medium Cohesive to granular soil, 45 PSF per foot of depth. Clay with unconfined compressive strength greater than 0.5 TSF but less than 1.5 TSF. Cohesionless gravel, silt, silt loam or sandy loam. See note 8.
TYPE C	20 FEET	1200	Soft Cohesive to Saturated Soil, 60 PSF per foot of depth. Clay with unconfined compressive strength less than 0.5 TSF, saturated sand, clay or fractured rock that is not stable. See note 9.



LIMITATIONS

- 1) Soil above shield must be sloped according to OSHA Subpart P. Slope must begin no less than 18" below the top of shield.
- 2) Shield may be suspended no more than 2 feet above bottom of the trench and only if there is no possible loss of soil from behind or below bottom of shield.
- 3) A minimum of 2 spreader pipes are required on each end with manufacturer approved pins and keepers.
- 4) Repairs and modifications must first be approved by manufacturer or registered professional engineer.
- 5) Shields may be stacked as long as each is rated to the depth it is used and manufacturer approved stack connections are utilized to prevent lateral movement of the shields.
- 6) Surcharge loads have not been included in the above depth ratings. The allowable working depth of the shield must be reduced to account for any surcharge loading which occurs within the influence line of the shield.
- 7) Not Type A if fissured. Subject to vibration, previously disturbed or part of a sloped layered system where layers dip into excavation on a slope of four horizontal to one vertical (4H:1 V) or greater.
- 8) Previously disturbed soils may be Type B unless they would be classed as Type C. Soil that meets requirements of Type A but is subject to vibration or fissured may be Type B. Dry rock that is not stable or soil that is part of a sloped layered system where layers dip into the excavation on a slope less steep than four horizontal to one vertical (4H:1V) are Type B if material would otherwise be classified as Type B.
- 9) Soil in a sloped layered system where layers dip into the excavation on a slope of four horizontal to one vertical (4H:1V) or steeper may be Type C. Saturated soil or soils from which water is freely seeping but is not standing in the trench. Conditions more severe would require dewatering or the sealing of four sides of the excavation and pumping the trench. Such severe conditions would require the services of a soils engineer to establish the design pressure. Consult the manufacturer for pressures exceeding tabulated values.
- 10) PRO-TEC trench shields are to be used in accordance with Federal, state and Local laws. Refer to Occupational Safety and Health Administration (OSHA) rules and regulations Vol. 54, No. 209, 10/31/89, Part 1926, Subpart P.



Scott M. Gillett

Usage of trench shields other than specified could cause failure or cave-ins resulting in serious injury or death.

How to ASSEMBLE a trench shield:



1. Remove from truck by lifting panels with 4 point lift lugs. Always use OSHA approved slings.

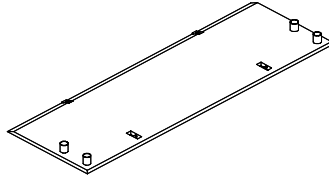

2. Place one sidewall flat on the ground with collars pointing up.

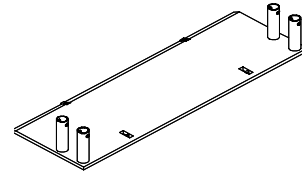

3. Set the spreader pipes over the collars and insert pins and keepers.



4. Set matching panel over bottom panel. Install Spreader pipes in collars and insert pins and keepers.

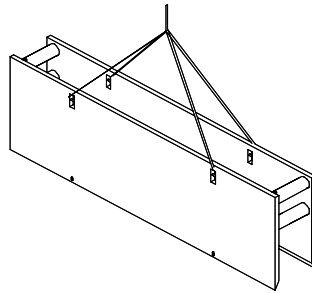

5. Place sling in top 4 lift lugs. Stand shield and install into trench.



6. **WARNING:** Lift eyes are designed and intended for assembly and lifting only. Do not pull or lift by eyes when shield is stuck or has pressure against it. Loosen shield by pulling on spreader or digging along sides before using lift eyes.

How to use a trench shield in STABLE soils:



1. Excavate trench to grade, slightly wider than shield. Lift and lower shield into trench.



2. Perform desired work, then excavate in front of shield.



3. Pull shield forward by front spreaders or pulling eyes. Continue excavating and pull shield forward. Back fill as work progresses.

How to use a trench shield in UNSTABLE soils:



1. Excavate until soil begins to crumble beyond desired trench width. Place shield on line of excavation and excavate from within.



2. Continue excavating with in shield while alternately pushing down on shield corners, until proper grade is reached.

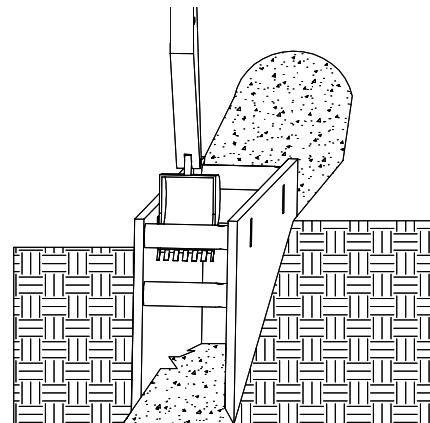

3. Perform desired work, then pull shield forward and up at appropriate angle and repeat steps (2) and (3) as necessary.