

# J.M. TURNER ENGINEERING, INC. CONSULTING ENGINEERS

CIVIL, STRUCTURAL, & CONSTRUCTION ENGINEERING

1325 College Avenue \* Santa Rosa, CA 95404 \* Phone (707) 528-4503 \* Fax (707) 528-4505

## E-MAIL TRANSMITTAL COVER SHEET

TO: Alvaro Romero  
COMPANY: Trebor Shoring Rentals  
PHONE: 714-994-8728  
E-MAIL: alvaro@tsrca.com

FROM: Hans Vermeulen  
DATE: 9-01-2017  
PAGES: 03 including cover sheet  
RE: Tabulated Data

E-MAILED BY: HV TIME: 9:45 am

### MESSAGE:

CA stamp Efficiency XLD-1024, sn 153365

Please note that mailed copies are available upon request.

Thank you for your business!

**MODEL:** XLD-1024

**5-PIPE "I"**

**MAX SPREADER LENGTH** 20 FEET

**KNIFE-EDGE** YES

**FOAM FILLER** YES

**COLLAR TYPE** 7" O.D. x 3/4" WALL  
 w/2" PIN HOLES

**DATE OF MANUFACTURE** Mar-16

**LIFT-LUG RATING** 5,832 LBS

**WEIGHT AS MANUFACTURED** 13,190 lbs

REFERENCE TO OCCUPATIONAL SAFETY AND HEALTH ADMINISTRATION RULES AND REGULATIONS, 29 CFR, NO 209, PART 1926, SUBPART P

SHIELD SIZE		PSF RATING	EXAMPLES OF MAXIMUM ALLOWABLE DEPTH OF CUT (FEET) IN SOIL TYPE TO BE EXCAVATED		
HEIGHT (FEET)	LENGTH (FEET)	MAXIMUM LATERAL EARTH PRESSURE CAPACITY AT TRENCH BOTTOM IN POUNDS PER SQUARE FOOT	TYPE B-45 (II) MEDIUM COHESIVE TO GRANULAR SOIL 45 PSF PER FT OF DEPTH	TYPE C-60 (III) SOFT COHESIVE TO SATURATED SOIL, 60 PSF PER FT OF DEPTH	TYPE C-80 (IV) SOFT SUBMERGED AND FLOWING SOIL, 80 PSF PER FT OF DEPTH
10	24	900	20	15	11
LIMITATIONS IN USE OF TABLE			DESCRIPTION	DESCRIPTION	DESCRIPTION
1. TRENCH SHIELD TO BE ASSEMBLED AND INSTALLED IN ACCORDANCE WITH MANUFACTURER'S INSTRUCTIONS. (SEE PAGE-2) 2. EXCAVATION 2 FEET BELOW BOTTOM OF SHIELD IS PERMITTED WHEN NO LOSS OF SOIL FROM BEHIND OR BELOW THE BOTTOM OF SHIELD IS ENCOUNTERED. SEE PARAGRAPH 1926.652 (e)(2)(i). THE COMPETENT PERSON SHALL MAKE THE DETERMINATION FOR COMPLIANCE. SUDDEN SHIFTING OF THE SHIELD VERTICALLY SHALL BE AVOIDED. 3. DEPTH RATING IS BASED ON TEMPORARY LOADING, CONSULT MANUFACTURER IF SHIELD IS SUBJECT TO LONG TERM LOADING 4. ADDITIONAL SHIELDS MAY BE STACKED WITH NO PENALTY IN DEPTH OF CUT AS LONG AS THE RATING OF THE EACH SHIELD IS NOT EXCEEDED AT THE DEPTH IT IS USED. MANUFACTURER APPROVED STACKING METHOD MUST BE USED. 5. C-80 DOES NOT REPRESENT THE WORST POSSIBLE SOIL CONDITION. OBTAIN SITE-SPECIFIC ENGINEERING FOR EXTREMELY NON-STABLE CONDITIONS SUCH AS MARINE CLAY, PEAT, SOFT SUBMERGED AND FLOWING CLAYS, ETC. 6. ANY MODIFICATIONS OR ALTERATIONS NOT ALLOWED UNLESS APPROVED IN WRITING BY EFFICIENCY PRODUCTION, INC. 7. CONTRACTOR'S COMPETENT/QUALIFIED PERSON SHALL BE RESPONSIBLE FOR MONITORING SOIL CONDITIONS AND SHALL BE RESPONSIBLE FOR COMPLIANCE WITH ALL FEDERAL, STATE AND LOCAL LAWS, RULES, AND REGULATIONS. 8. SPREADER PINS SHALL BE #620 COLD DRAWN 80-90 KSI MIN. YIELD AND NO MORE THAN 1/4" SMALLER THAN COLLAR AND SPREADER PIN HOLES AS MANUFACTURED BY EFFICIENCY PRODUCTION, INC. 9. LIFT LUG RATING IS (THE SAFE WORKING LOAD) FOR EACH INDIVIDUAL LIFT LUG. 10. WEIGHT LISTED IS FOR SHIELD ONLY. USE ASSEMBLED WEIGHT INCLUDING SPREADERS FOR RIGGING PURPOSES			CLAY, WITH UNCONFINED COMPRESSIVE STRENGTH GREATER THAN 0.5 TSF BUT LESS THAN 1.5 TSF COHESIONLESS GRAVEL, SILT, SILT LOAM OR SANDY LOAM	SOFT COHESIVE SOIL UNCONFINED COMPRESSIVE STRENGTH GREATER THAN 0.3 TSF, BUT LESS THAN 0.5 TSF CLAY, SAND AND LOAMY SAND; SATURATED SOIL THAT IS STABLE, DRY SAND, OR DEWATERED SOILS	SOFT COHESIVE SOIL UNCONFINED COMPRESSIVE STRENGTH LESS THAN 0.3 TSF. FRACTURED ROCK THAT IS NOT STABLE, OR SUBMERGED SAND AND LOAMY SAND THAT IS FLOWING. (SEE NOTE 5)

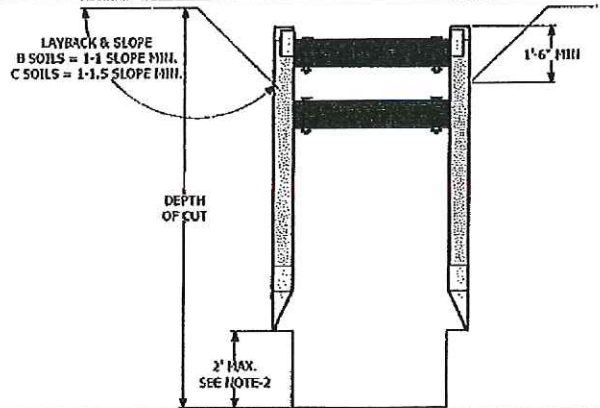

MANUFACTURED UNDER ONE OR MORE OF THE FOLLOWING U.S. PATENT NUMBERS: 4,090,365-4,114,383-4,259,028 ONE OR MORE OF THE FOLLOWING CANADIAN PATENT NUMBERS: 1,062,683-1,062,684

**CERTIFIED BY:**  
 EFFICIENCY PRODUCTION INC.

**COPYRIGHT:** 1991  
 EFFICIENCY PRODUCTION INC.  
 ALL RIGHTS RESERVED

CONTINUED ON REVERSE SIDE



3/22/2016



4/11/17

**WARNING:** Any use of this product not specifically described on this certificate could cause cave-in, collapse, or structural failure, and may result in injury or death.

- NOT TYPE A IF FISSURED, SUBJECT TO VIBRATION, PREVIOUSLY DISTURBED OR PART OF A SLOPED LAYERED SYSTEM WHERE LAYERS DIP INTO EXCAVATION ON A SLOPE OF FOUR HORIZONTAL TO ONE VERTICAL (4H:1V) OR GREATER.
- PREVIOUSLY DISTURBED SOILS MAY BE TYPE B UNLESS THEY WOULD BE CLASSIFIED AS TYPE C. SOIL THAT MEETS THE REQUIREMENTS OF TYPE A, BUT IT IS SUBJECT TO VIBRATION OR FISSURED MAY BE TYPE B. DRY ROCK THAT IS NOT STABLE OR SOIL THAT IS PART OF A SLOPED, LAYERED SYSTEM WHERE LAYERS DIP INTO THE EXCAVATION ON A SLOPE LESS STEEP THAN FOUR HORIZONTAL TO ONE VERTICAL (4H:1V) ARE TYPE B BUT ONLY IF MATERIAL WOULD OTHERWISE BE CLASSIFIED AS TYPE B.
- SOIL IN A SLOPED LAYERED SYSTEM WHERE LAYERS DIP INTO THE EXCAVATION ON A SLOPE OF FOUR HORIZONTAL TO ONE VERTICAL (4H:1V) OR STEEPER MAY BE TYPE C. SUBMERGED SOIL IS MATERIAL WITH WATER FREELY SEEPING AND ENTERING THE TRENCH, BUT ONLY PART OF THE DEPTH OF THE RETAINED SOIL IS SUBMERGED. CONDITIONS MORE SEVERE WOULD REQUIRE DEWATERING OR SEALING FOUR SIDES OF THE EXCAVATION AND PUMPING THE TRENCH, SUCH SEVERE CONDITIONS WOULD REQUIRE THE SERVICES OF A LICENSED GEOTECHNICAL ENGINEER TO ESTABLISH THE DESIGN PRESSURE. CONSULT THE MANUFACTURER FOR PRESSURES EXCEEDING TABULATED VALUES.
- ANY SOIL THAT WILL STAND UNSUPPORTED LONG ENOUGH TO INSTALL TRENCH SHIELD MAY BE CLASSIFIED AS C-60
- ANY USE OF A TRENCH SHIELD WITHOUT EFFICIENCY SPREADERS AND PINS OR EQUAL WILL VOID THE TABULATED DATA AND WARRANTY.
- SHIELD WAS DESIGNED TO BE USED WITHOUT PLATES EXTENDING BELOW, ABOVE, OR NEXT TO IT. ANY USE OF SUCH PLATES OR PANELS MAY VOID THE TABULATED DATA AND MAY REQUIRE SITE SPECIFIC ENGINEERING PREPARED BY A LICENSED PROFESSIONAL ENGINEER.
- TRENCH SHIELDS ARE DESIGNED TO BE PUSHED TO GRADE IF NECESSARY. AS NOTED BELOW, ANY UNNECESSARY ABUSE BY THE EXCAVATOR AND/OR OPERATOR (SUCH AS POUNDING WITH THE BUCKET) WILL VOID THE TABULATED DATA AS WELL AS THE WARRANTY.
- CONDITION OF SHIELD, SPREADER PIPES, AND SPREADER PINS MUST BE CHECKED/INSPECTED FOR SERVICEABILITY BY THE COMPETENT PERSON PRIOR TO EACH USE. PSF RATING IS NOT VALID IF THERE IS ANY VISIBLE DAMAGE TO, OR REPAIRS MADE TO THE SHIELD THAT HAS NOT BEEN DOCUMENTED AND CERTIFIED BY A REGISTERED PROFESSIONAL ENGINEER.
- A MINIMUM OF 2 SPREADERS, 1 ARCH, OR 1 SPREADER AND 1 MUDPLATE MUST BE INSTALLED ON EACH END OF TRENCH SHIELD PRIOR TO USE.
- DEPTH AND PSF RATING ARE FOR LATERAL EARTH PRESSURES ONLY. AN ADDITIONAL LATERAL SURCHARGE PRESSURE UP TO 72PSF IS ALLOWED

**ASSEMBLY (DIS-ASSEMBLE SHIELD IN REVERSE ORDER)**

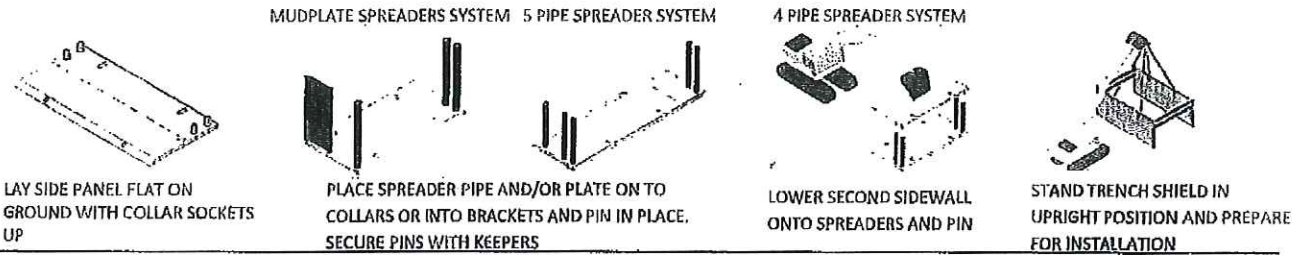

**USING A TRENCH SHIELD IN STABLE SOIL**

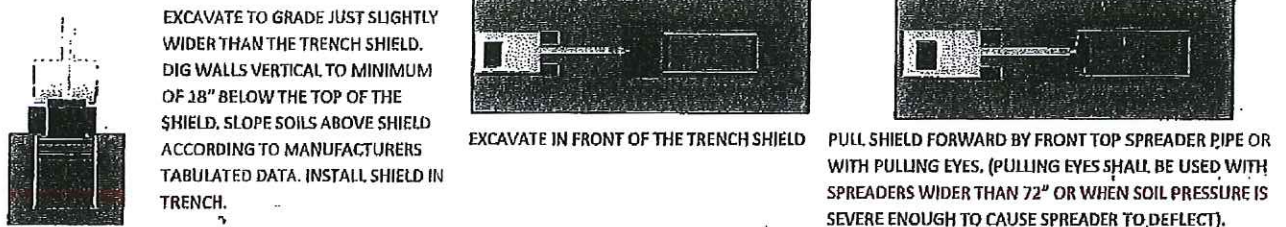

**USING A TRENCH SHIELD IN UNSTABLE SOIL**

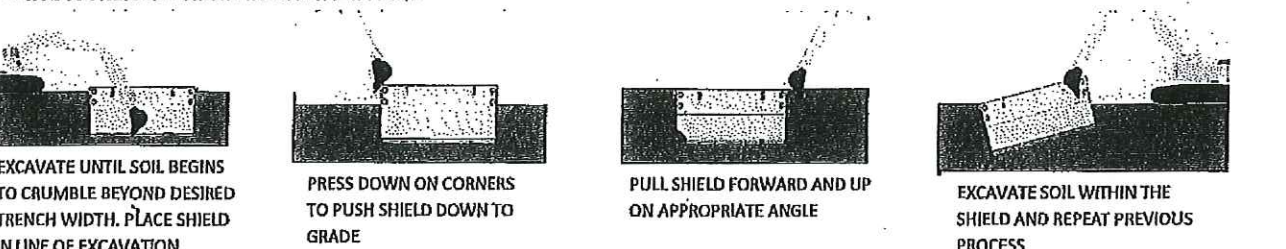

**USING TRENCH SHIELDS FOR PATCHWORK, REPAIRS OR TIE-INS**

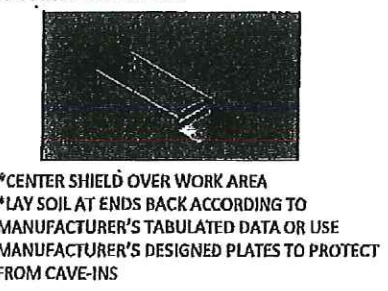

**MANHOLE BOX W/CORNER END PLATES**

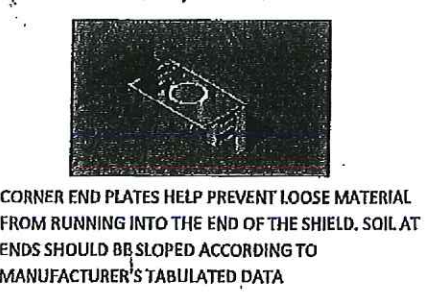

**USING 4-SIDED SHIELDS**

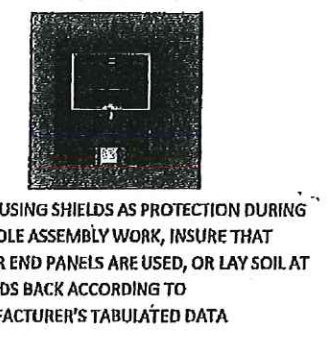

\*THIS MATERIAL IS INTENDED TO PROVIDE BASIC ASSEMBLY AND INSTALLATION INFORMATION ONLY. \*ALWAYS USE TRENCH SHIELD IN ACCORDANCE WITH APPLICABLE LOCAL, STATE, AND FEDERAL SAFETY LAWS AND REGULATIONS. \*FAILURE TO DO SO COULD CAUSE SEVERE INJURY OR DEATH.