

MODEL: XLD-1010

4 PIPE "1"

MAX SPREADER LENGTH

20 FEET

KNIFE-EDGE

NO

FOAM FILLER

NO

COLLAR TYPE

**7" O.D. x 3/4" WALL
w/2" 1/4 PIN HOLES**

DATE OF MANUFACTURE

Oct-14

LIFT-LUG RATING

5,832 LBS

WEIGHT AS MANUFACTURED

6,745 LBS

REFERENCE TO OCCUPATIONAL SAFETY AND HEALTH ADMINISTRATION RULES AND REGULATIONS, 29 CFR, NO 209, PART 1926, SUBPART P

SHIELD SIZE		PSF RATING	EXAMPLES OF MAXIMUM ALLOWABLE DEPTH OF CUT (FEET) IN SOIL TYPE TO BE EXCAVATED		
HEIGHT (FEET)	LENGTH (FEET)	MAXIMUM LATERAL EARTH PRESSURE CAPACITY AT TRENCH BOTTOM IN POUNDS PER SQUARE FOOT	TYPE B-45 (II) MEDIUM COHESIVE TO GRANULAR SOIL 45 PSF PER FT OF DEPTH	TYPE C-60 (III) SOFT COHESIVE TO SATURATED SOIL. 60 PSF PER FT OF DEPTH	TYPE C-80 (IV) SOFT SUBMERGED AND FLOWING SOIL. 80 PSF PER FT OF DEPTH
10	10	2640	59	44	33

LIMITATIONS IN USE OF TABLE

- TRENCH SHIELD TO BE ASSEMBLED AND INSTALLED IN ACCORDANCE WITH MANUFACTURER'S INSTRUCTIONS. (SEE PAGE-2)
- EXCAVATION 2 FEET BELOW BOTTOM OF SHIELD IS PERMITTED WHEN NO LOSS OF SOIL FROM BEHIND OR BELOW THE BOTTOM OF SHIELD IS ENCOUNTERED. SEE PARAGRAPH 1926.852 (e)(2)(i). THE COMPETENT PERSON SHALL MAKE THE DETERMINATION FOR COMPLIANCE. SUDDEN SHIFTING OF THE SHIELD VERTICALLY SHALL BE AVOIDED.
- DEPTH RATING IS BASED ON TEMPORARY LOADING, CONSULT MANUFACTURER IF SHIELD IS SUBJECT TO LONG TERM LOADING
- ADDITIONAL SHIELDS MAY BE STACKED WITH NO PENALTY IN DEPTH OF CUT AS LONG AS THE RATING OF THE EACH SHIELD IS NOT EXCEEDED AT THE DEPTH IT IS USED. MANUFACTURER APPROVED STACKING METHOD MUST BE USED.
- C-80 DOES NOT REPRESENT THE WORST POSSIBLE SOIL CONDITION. OBTAIN SITE-SPECIFIC ENGINEERING FOR EXTREMELY NON-STABLE CONDITIONS SUCH AS MARINE CLAY, PEAT, SOFT SUBMERGED AND FLOWING CLAYS, ETC.
- ANY MODIFICATIONS OR ALTERATIONS NOT ALLOWED UNLESS APPROVED IN WRITING BY EFFICIENCY PRODUCTION, INC.
- CONTRACTOR'S COMPETENT/QUALIFIED PERSON SHALL BE RESPONSIBLE FOR MONITORING SOIL CONDITIONS AND SHALL BE RESPONSIBLE FOR COMPLIANCE WITH ALL FEDERAL, STATE AND LOCAL LAWS, RULES, AND REGULATIONS.
- SPREADER PINS SHALL BE 8620 COLD DRAWN 80-90 KSI MIN. YIELD AND NO MORE THAN 1/4" SMALLER THAN COLLAR AND SPREADER PIN HOLES AS MANUFACTURED BY EFFICIENCY PRODUCTION, INC.
- LIFT LUG RATING IS (THE SAFE WORKING LOAD) FOR EACH INDIVIDUAL LIFT LUG.
- WEIGHT LISTED IS FOR SHIELD ONLY. USE ASSEMBLED WEIGHT INCLUDING SPREADERS FOR RIGGING PURPOSES

DESCRIPTION	DESCRIPTION	DESCRIPTION
CLAY, WITH UNCONFINED COMPRESSIVE STRENGTH GREATER THAN 0.5 TSF BUT LESS THAN 1.5 TSF COHESIONLESS GRAVEL, SILT, SILT LOAM OR SANDY LOAM	SOFT COHESIVE SOIL UNCONFINED COMPRESSIVE STRENGTH GREATER THAN 0.3 TSF, BUT LESS THAN 0.5 TSF CLAY, SAND AND LOAMY SAND; SATURATED SOIL THAT IS STABLE, DRY SAND, OR DEWATERED SOILS	SOFT COHESIVE SOIL UNCONFINED COMPRESSIVE STRENGTH LESS THAN 0.3 TSF. FRACTURED ROCK THAT IS NOT STABLE, OR SUBMERGED SAND AND LOAMY SAND THAT IS FLOWING. (SEE NOTE 5)

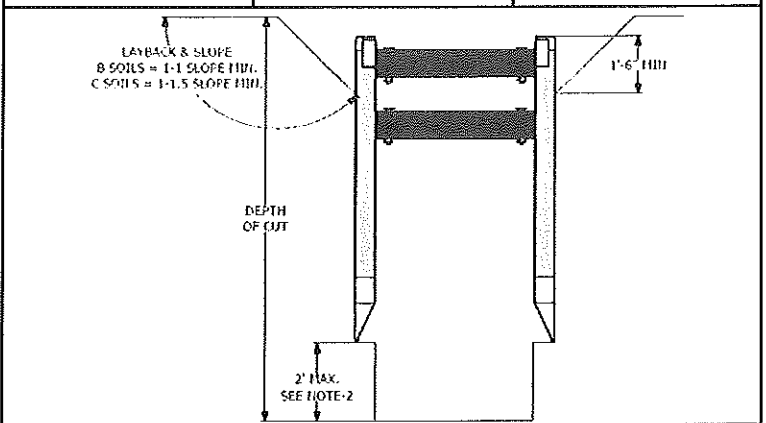

MANUFACTURED UNDER ONE OR MORE OF THE FOLLOWING U.S. PATENT NUMBERS: 4,090,365-4,114,383-4,259,028 ONE OR MORE OF THE FOLLOWING CANADIAN PATENT NUMBERS: 1,062,683-1,062,684

CERTIFIED BY: EFFICIENCY PRODUCTION INC.
COPYRIGHT: 1991 EFFICIENCY PRODUCTION INC. ALL RIGHTS RESERVED

CONTINUED ON REVERSE SIDE



10/29/2014

WARNING: Any use of this product not specifically described on this certificate could cause cave-in, collapse, or structural failure, and may result in injury, or death